



ANICO

Εργοστάσιο Επεξεργασίας Σιδήρου

## «Για κάθε τύπο περίφραξης»

**M**ετά από 30 χρόνια πορείας, η εταιρία ANCO ΚΩΝΣΤΑΝΤΙΝΟΥ Α.Β.Ε.Ε. διαθέτει τον κατάλληλο μηχανολογικό εξοπλισμό αλλά και την τεχνογνωσία για κάθε τύπο περίφραξης.

### Παραδοσιακός τύπος:

Δεν είναι τυχαίο που το παραδοσιακό γοητεύει έως σήμερα. Παραδοσιακό σημαίνει κλασικό! Περίτεχνα παραδοσιακά σχέδια από μασίφ σίδηρο, σφυρηλατημένα, με τέλεια αισθητική και αξιοσημείωτη αντοχή στο χρόνο δίνουν στην κατοικία μία αίσθηση αρχοντίας και λάμψης.

### Βιομηχανικός τύπος:

Η εξέλιξη στον κατασκευαστικό χώρο απαιτεί υψηλή ποιότητα, ανθεκτικότητα και ακρίβεια. Γι' αυτό το λόγο επενδύσαμε σε σύγχρονα αυτοματοποιημένα μηχανήματα, δημιουργώντας μια μονάδα παραγωγής άξια να αντεπεξέλθει σε κάθε τεχνική προδιαγραφή. Ο συγκεκριμένος τύπος ενδείκνυται για βιομηχανικούς χώρους, λιμενικά και δομικά έργα.

### Λαμαρινοειδής τύπος:

Η μεγάλη ποικιλία οπών και διατομών εξυπηρετεί τη λιτή και μοντέρνα γραμμή κατασκευής. Η λεπτομερής ψηφιακή σχεδίαση CAD και η ακριβής κοπή και διαμόρφωση σε CNC μηχανήματα προσφέρουν ένα άρτιο αποτέλεσμα με εξαιρετικό επίπεδο ακρίβειας.

Η διεύρυνση της ποικιλίας των προϊόντων μας αποσκοπεί στη διευκόλυνση της επιλογής σας ανάλογα με τον τύπο που εσείς χρειάζεστε.

Με εκτίμηση,  
Ανδρέας Κωνσταντίνου

## «For every type of fencing»

**A**fter 30 years of experience in this field, the ANCO CONSTANTINOU S.A has the appropriate machinery as well as the practical knowledge skill and experience for every type of fencing.

### Traditional type:

No wonder that this type is always considered enchanting. Traditional means classic! Elaborate traditional designs of forged solid iron of perfect aesthetic and remarkable resistance add to a house a sense of nobility and glamour.

### Industrial type:

Developments in the construction field require high quality, durability and accuracy. For this reason we have invested in modern automatic machinery, creating a production unit worthy to cope with any technical specifications. This certain type is appropriate for industrial areas, port and building works.

### Sheet metal type:

The great variety of holes and cross-sections serve a simple and modern line of construction. A detailed digital design CAD, as well as a precise cutting and shaping in CNC machinery offer a perfect result with excellent level accuracy.

The expansion of our product range is designed to facilitate your choice depending on the type you need.

With cordial regards,  
Andreas Constantinou

ANCO





**Πιστοποίηση**  
Απονέμεται στην Εταιρεία

**ANCO ΚΩΝΣΤΑΝΤΙΝΟΥ Α.Β.Ε.Ε.**  
Κεντρικό Κατάστημα: Λεωφ. Κορωπίου-Μακροπούλου 51, ΤΚ 194 00  
Υποκατάστημα: Λεωφ. Βουλιαγμένης 324 & Σοφίου 7,  
ΤΚ 17342 Αγ. Δημήτριος, Αθήνα  
ΕΛΛΑΔΑ

Το Bureau Veritas Certification πιστοποιεί ότι το Σύστημα Διαχείρισης της ποιότητας οργανισμού έχει αξιολογηθεί και καλύπτει τις απαιτήσεις των παρακάτω προτύπων διαχείρισης συστημάτων:

---

Πρότυπο  
**ISO 9001:2008**  
Αντικείμενο Πιστοποίησης

---

**ΠΑΡΑΓΩΓΗ ΚΑΙ ΕΜΠΟΡΙΑ ΣΙΔΕΡΕΝΩΝ ΚΙΓΚΑΛΙΔΩΜΑΤΩΝ,  
ΥΛΙΚΩΝ ΠΕΡΙΦΡΑΣΗΣ ΚΑΙ ΣΧΑΡΩΝ.**

Αρμόδια Ημερομηνία Έγκρισης: **01 Μαρτίου, 2010**

Με κριτήριο ότι το Σύστημα Διαχείρισης της ποιότητας θα συνεχίσει να λειτουργεί κανονικά, το πιστοποιητικό έγκρισης ισχύει μέχρι **28 Φεβρουαρίου, 2013**

Για να κληθεί ηγ-ηγετική και πιστοποιητική παροχή επικοινωνήστε στο + 30 210 4063 000.  
Παραβιβάσεις κληρονομία ισχύει με τα στοιχεία του αρχικού πιστοποιητικού και του κωδικού του πιστοποιητικού διατηρείται, σύμφωνα με διατάξεις από τον οργανισμό.

**N. ΤΡΙΑΦΑΖ**  
Ημερομηνία: 02 Μαρτίου, 2010  
Αρ. Πιστοποιητικού: **GR14636Q**

008

Bureau Veritas Certification (UKAS) is a registered company in the United Kingdom, registered number 2720954, registered office: 110 South Colindale Avenue, London, NW9 7EQ, UK. UKAS is a member of the United Kingdom Accreditation Body (UKAS) and is authorized to issue certificates of conformity to the requirements of the ISO 9001:2008 standard.



►► Περιεχόμενα / Contents



**10**  
Λόγχες σιδήρου  
πρεσαριστές  
Moulded iron  
spears



**34**  
Μοτίφ  
διακοσμητικά  
Decorative  
motifs



**14**  
Λόγχες σιδήρου  
διακοσμητικές  
Decorative iron  
spears

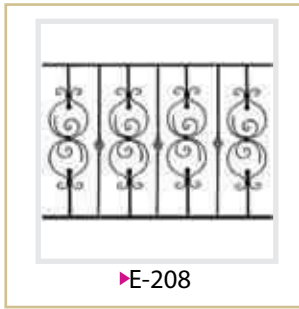

**74**  
Παραδείγματα  
περίφραξης  
Fences  
samples

►E-208



**18**  
Ασφάλειες  
παραθύρων  
Security  
window frames



**78**  
Κολόνες  
σφυρήλατες  
Forged  
posts



**24**  
Καράβολοι  
Κύκλοι  
Scrolls  
Circles



**80**  
Σκάλες  
εσωτερικού χώρου  
Interior  
stairs



**26**  
Διακοσμητικά  
φουρούσια  
Decorative  
brackets



**90**  
Μοτίφ  
σωληνωτά  
Ornamental  
motifs



**28**  
Μοτίφ  
σφυρήλατα  
Forged  
motifs



**92**  
Κουπαστές  
Λάμες διακοσμητικές  
Decorative  
handrails



94

Τελειώματα κουπαστής  
Handrail finishes



116

Φύλλα - Ροζέτες  
Leaves  
Decorative rosette



97

Διάτρητες βέργες  
Drilled bars



118

Διακοσμητικά είδη σπιτιού  
Decorative house items



98

Σφυρήλατες βέργες  
Κοιλοδοκοί  
Forged bars  
Hollow bars



120

Πτυσσόμενες πόρτες ασφαλείας  
Security folding doors & windows



100

Διακοσμητικά χυτά στοιχεία  
Decorative cast items



124

Διάτρητες & laser λαμαρίνες  
Perforated & laser metal sheets



108

Διακοσμητικά πόρτας  
Door decorative items



142

Βιομηχανικές σχάρες  
Industrial grating



114

Διακοσμητικά κλειδαριές  
Decorative lock items

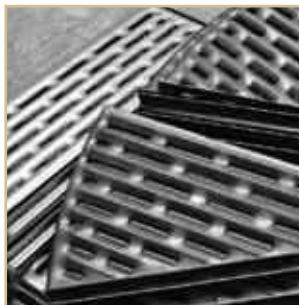

146

Πρεσαριστά σκαλοπάτια  
Welded stairs



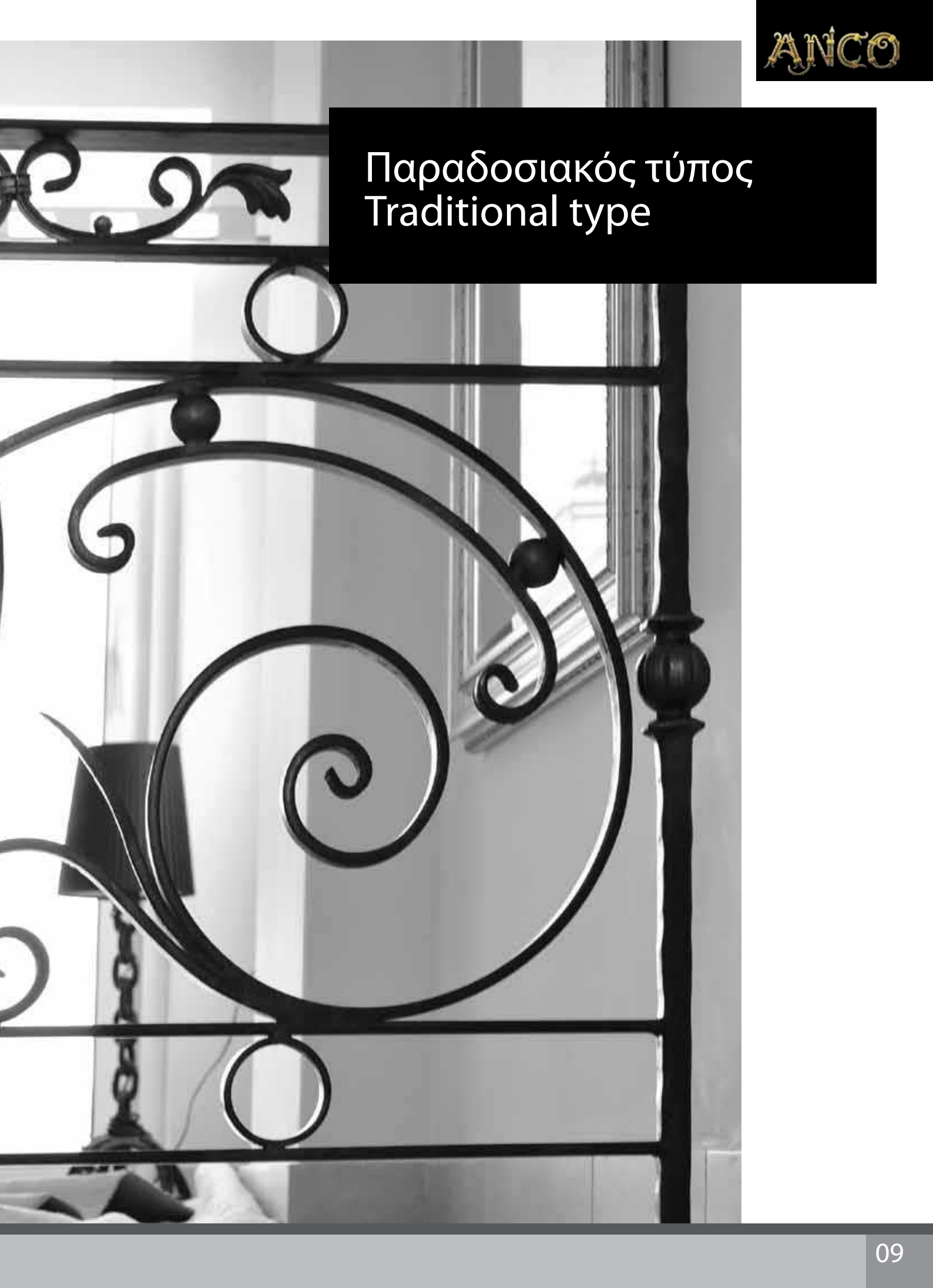

Παραδοσιακός τύπος  
Traditional type





# ▶▶ Λόγχες σιδήρου πρεσαριστές

## Moulded iron spears



▶ Λόγχη  
Απλή



▶ Λόγχη  
Φλόγα



▶ Λόγχη  
Βεργίνα



▶ Λόγχη  
Ρόμβος



▶ Χτένι



▶ Βελόνι



▶ Βελόνι  
Κατσαρό



▶ Βελόνι  
Καμπύλη



Όλες οι λόγχες κατασκευάζονται από:  
Ø 12/14/16/18/20 σε οποιοδήποτε ύψος.

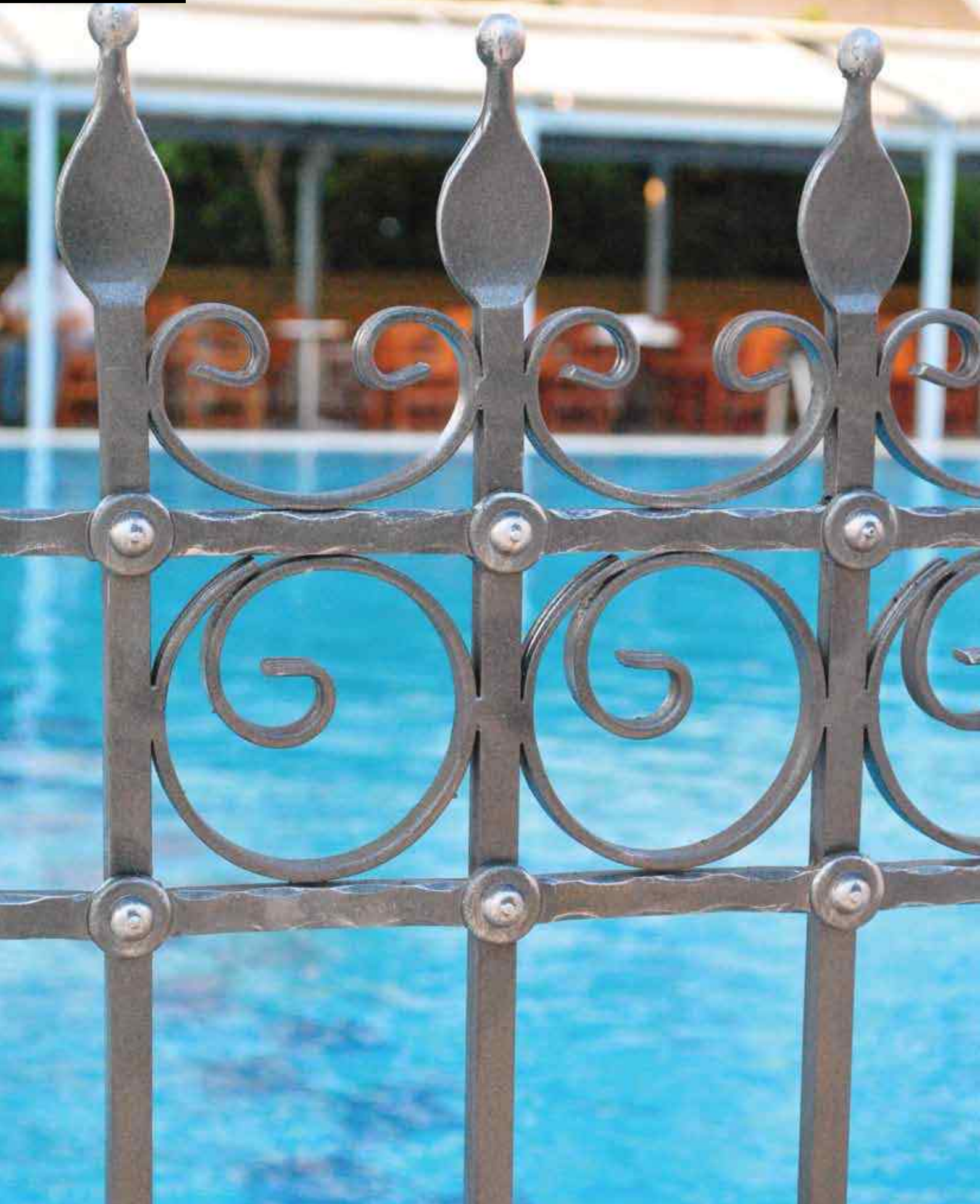

## ▶▶ Λόγχες σιδήρου πρεσαριστές Moulded iron spears



▶Φλόγα  
Μπίλια



▶Βεργίνα  
Μπίλια



▶Κουτάλι  
Μπίλια



▶Βελόνι  
Μπίλια



Όλες οι λόγχες κατασκευάζονται από:  
Ø 12/14/16/18/20 σε οποιοδήποτε ύψος.



▶No 17  
H.125xL.60mm  
Ø 30  
100



▶No 18  
H.200xL.65mm  
Ø 35  
50



▶No 19A  
H.190xL.92mm  
Ø 20  
50



▶No 19B  
H.160xL.75mm  
Ø 15  
80

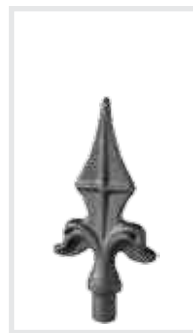

▶No 19Γ  
H.125xL.60mm  
Ø 12  
150



▶No 20A  
H.140 x L.80mm  
Ø 38  
50



▶No 20B  
H.125 x L.65mm  
Ø 25  
80



▶No 20Γ  
H.80 x L.45mm  
Ø 20  
100

# ▶▶ Λόγχες σιδήρου διακοσμητικές

## Decorative iron spears



▶No 21  
H.140xL.25mm  
∅ 14  
100



▶No 22  
H.140xL.95mm  
∅ 14  
100



▶No 23  
H.85xL.28mm  
∅ 28  
100



▶No 24  
H.140xL.66mm  
∅ 14  
100



▶No 25  
H.140xL.70mm  
∅ 14  
100



▶No 26  
H.140xL.60mm  
∅ 14  
100



▶No 27  
H.135xL.25mm  
∅ 14  
100



▶No 28  
H.110xL.30mm  
∅ 16  
100



▶No 29  
H.150 x L.40mm  
∅ 40  
30

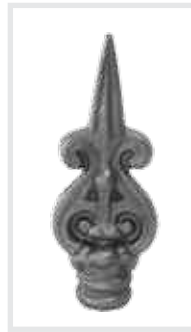

▶No 29A  
H.190 x L.70mm  
∅ 40  
20

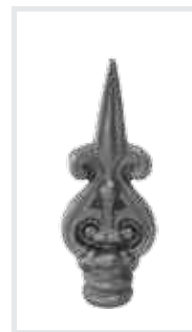

▶No 29B  
H.140xL.57mm  
∅ 33  
50



▶No 29Γ  
H.125xL.44mm  
∅ 25  
80



# ▶ Λόγγες σιδήρου διακοσμητικές Decorative iron spears



▶ No 30  
H.165 x L.85mm  
∅ 50  
20



▶ No 31  
H.165 x L.66mm  
∅ 22  
40



▶ No 32 & 33  
H.120 x L.35mm ∅ 30  
H.150 x L.40mm ∅ 33  
120 60



▶ No 35  
H.150 x L.32mm  
∅ 32  
100



▶ No 36  
H.120 x L.65mm  
∅ 25  
80



▶ No 37  
H.185 x L.85mm  
∅ 30  
40







## ▶▶ Ασφάλειες παραθύρων Security window frames



▶MK-1



▶MK-2



▶MK-3



▶MK-4



▶MK-5

Όλα τα κουρμπανιστά κατασκευάζονται από:  
□ 12/14 σε οποιοδήποτε ύψος.





# ▶▶ Ασφάλειες παραθύρων Security window frames



▶MK-6



▶MK-7



▶MK-8



▶MK-9



▶MK-10



▶MK-11



Όλα τα κουρμπανιστά κατασκευάζονται από:  
 ▣ 12/14 σε οποιοδήποτε ύψος.



## ▶▶ Ασφάλειες παραθύρων Security window frames



▶MK-12



▶MK-13



▶MK-14



▶MK-15



Όλα τα κουρμαριστά κατασκευάζονται από:  
☒ 12/14 σε οποιοδήποτε ύψος.



▶KS-190  
19 x 8cm  
100



▶KS-260  
26 x 11cm  
70



▶KS-330  
33 x 13cm  
50



▶KA-180  
18 x 136cm  
100



▶K-110  
11 x 6cm  
150



▶K-140  
14 x 9cm  
100



▶K-220  
22 x 13cm  
50



▶K-260  
26 x 13cm  
40



▶K-200  
20 x 11cm  
100



▶KΦ-180  
18 x 13cm  
100



▶KΦ-180  
18 x 11cm  
100



▶KΦ-460  
46 x 16cm  
40



▶KE-140  
14 x 8cm  
150



▶KE-180  
18 x 11cm  
100



▶KP-190  
19 x 16cm  
100



▶KP-210  
21 x 6cm  
100



▶KP-260  
26 x 28cm  
100

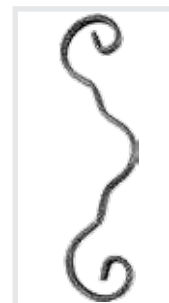

▶KP-270  
27 x 8cm  
70

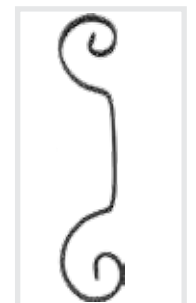

▶KP-360  
36 x 8cm  
40

## ►► Καράβολοι - Κύκλοι Scrolls - Circles



► KYK  
11 & 12cm  
100



► KM-110  
11 & 12cm  
150

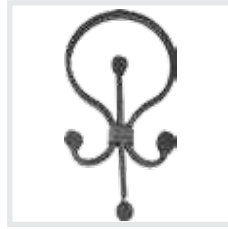

► KP-110  
36 x 8cm  
50

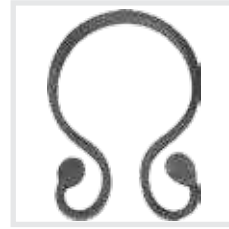

► KP-120  
36 x 8cm  
50



► KP-130  
36 x 8cm  
50



► KY-60  
Ø6cm  
100



► KY-80  
Ø8cm  
100



► KY-100  
Ø10cm  
100



► KY-110  
Ø11cm  
100



► KY-120  
Ø12cm  
100



► Καράβολοι  
διαφόρων διαστάσεων και  
διατομών κατόπιν παραγγελίας.



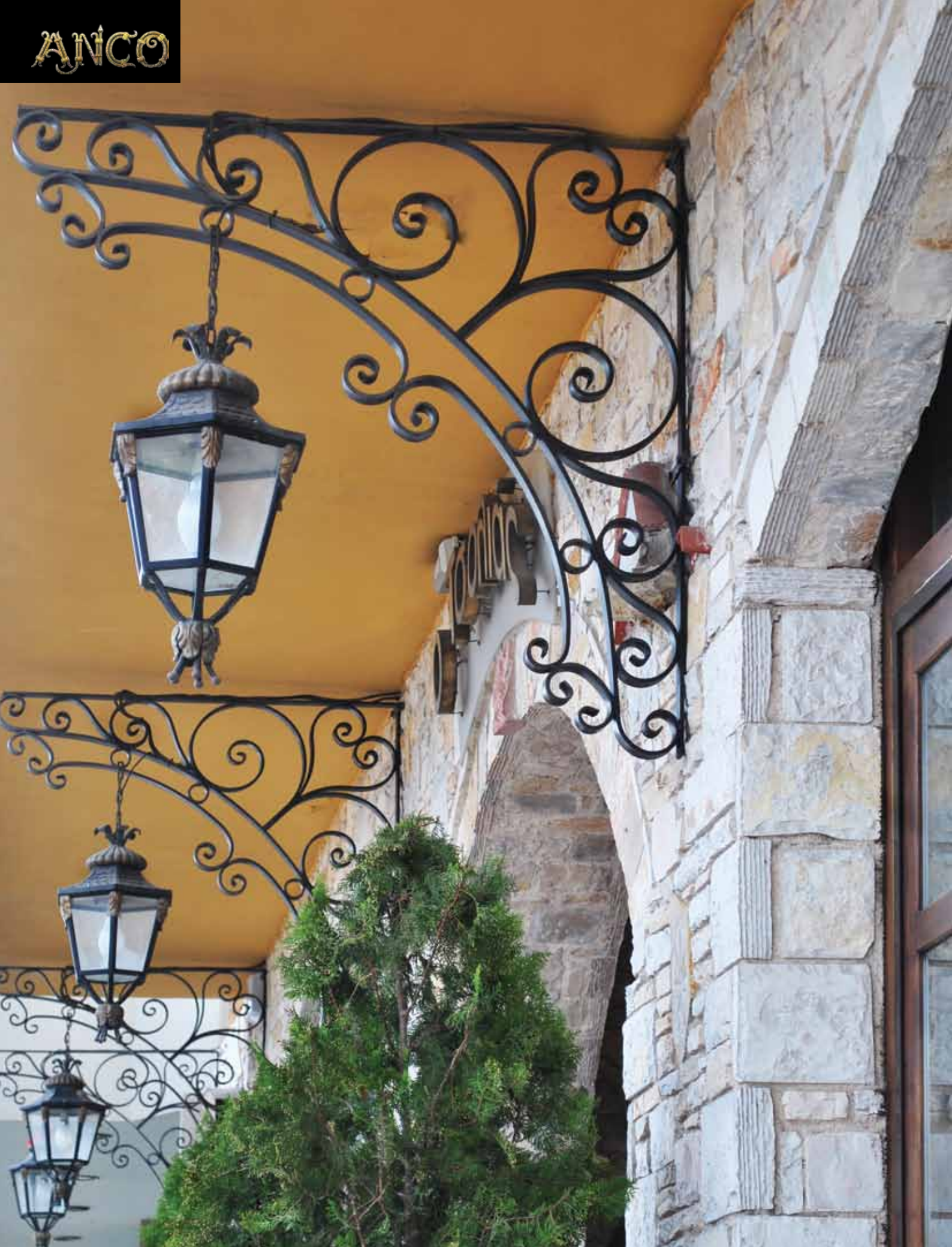

►► Διακοσμητικά  
Φουρούσια  
Decorative brackets



► ΦΣ01 H.410xL.1200mm



► ΦΣ02 H.500xL.1000mm



► ΦΣ03 H.500xL.1000mm

Ειδικές διαστάσεις και σχέδια  
κατόπιν παραγγελίας.



H.130xL.570mm

► ΦΣ04

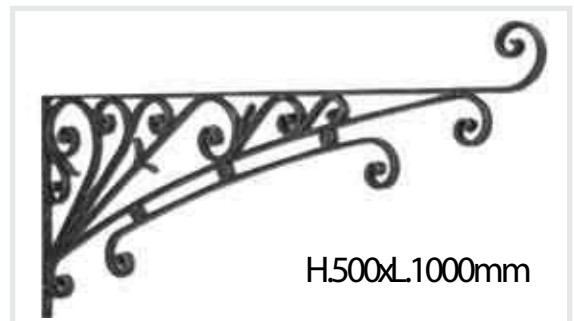

H.500xL.1000mm

► ΦΣ05



► ΦΣ06  
H.680xL.960mm



# ▶▶ Μοτίφ σφυρήλατα

## Forged motifs



▶M-100  
H.800mm  
∅12  
∅14



▶M-100/B  
H.800mm  
∅12  
∅14

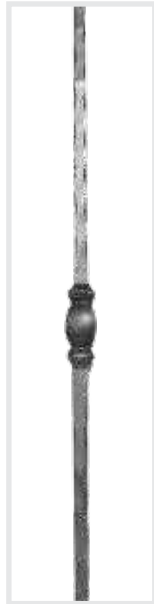

▶M-101/B  
H.800mm  
∅12  
∅14



▶M-101/B  
H.800mm  
∅12  
∅14



▶M-102  
H.800mm  
∅12  
∅14



▶M-102/B  
H.800mm  
∅12  
∅14



▶M-104  
H.800mm  
∅12  
∅14



▶M-104/B  
H.800mm  
∅12  
∅14



▶M-105  
H.800mm  
∅12  
∅14



▶M-105/B  
H.800mm  
∅12  
∅14



▶M-106  
H.800mm  
∅12  
∅14



▶M-106/B  
H.800mm  
∅12  
∅14

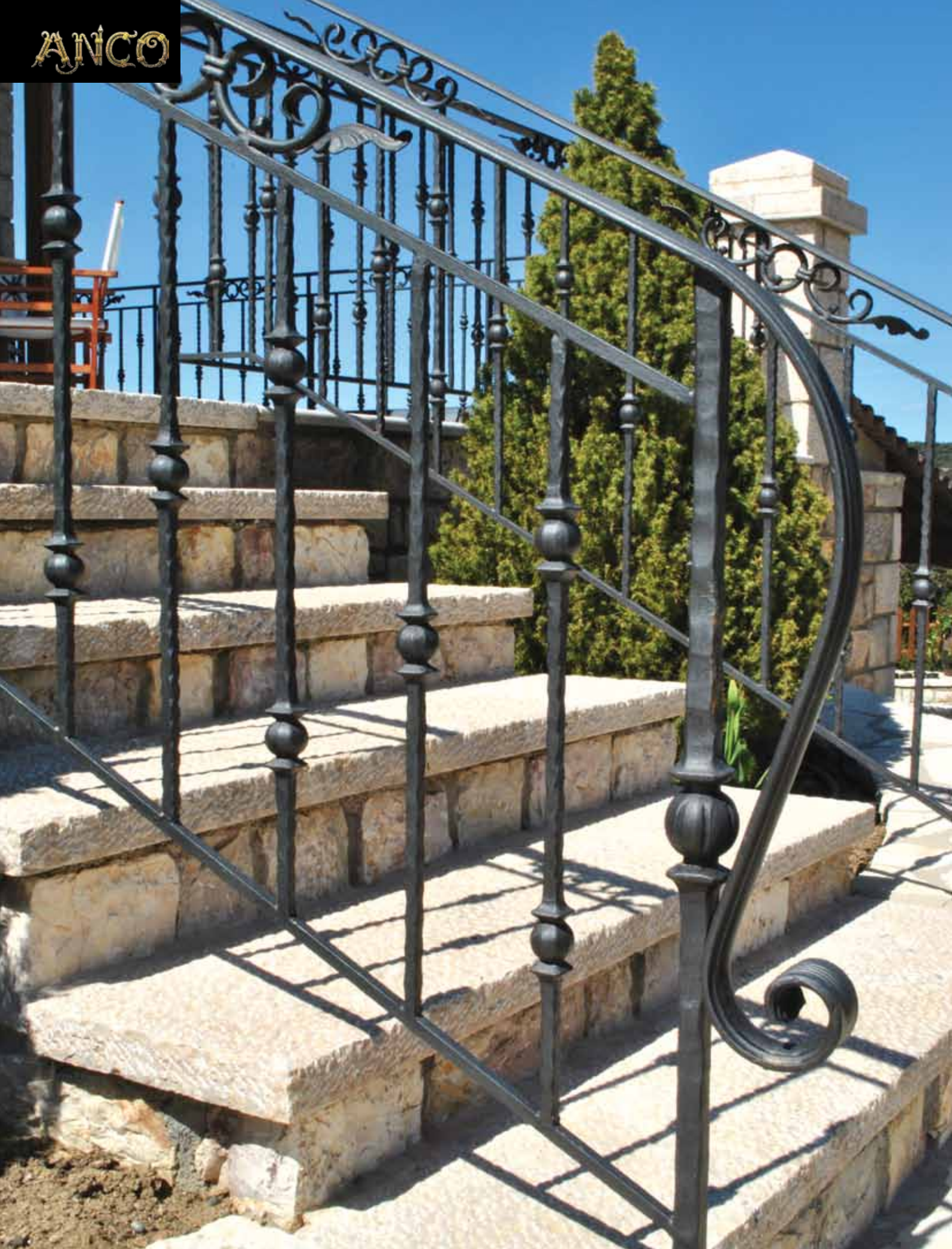

►► Μοτίφ σφυρήλατα  
Forged motifs



►M-107  
H.800mm  
∅12  
∅14



►M-107/B  
H.800mm  
∅12  
∅14





M-114  
H.800mm  
Ø14



M-114B  
H.800mm  
Ø14



M-115  
H.800mm  
Ø14



M-115/B  
H.800mm  
Ø14



M-116  
H.800mm  
Ø14



M-116/B  
H.800mm  
Ø14



M-117  
H.800mm  
Ø14



M-117/B  
H.800mm  
Ø14

►► Μοτίφ σφυρήλατα  
Forged motifs



M-104/1  
H.800mm  
∅12  
∅14



M-104/2  
H.800mm  
∅12  
∅14



M-104/3  
H.800mm  
∅12  
∅14



M-104/4  
H.800mm  
∅12  
∅14



M-104/5  
H.800mm  
∅12  
∅14



M-104/6  
H.800mm  
∅12  
∅14



▶▶ Μοτίφ διακοσμητικά  
Decorative motifs



▶M-37  
H.870 x L.350mm  
∅12 x 6  
∅14 x 5

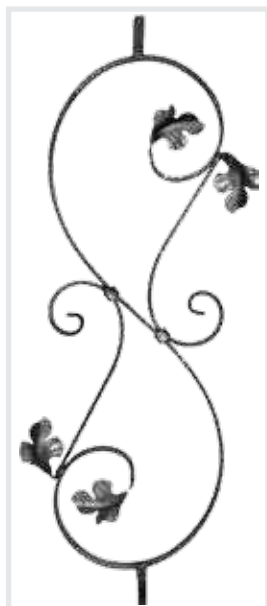

▶M-38  
H.800 x L.280mm  
∅14 x 5

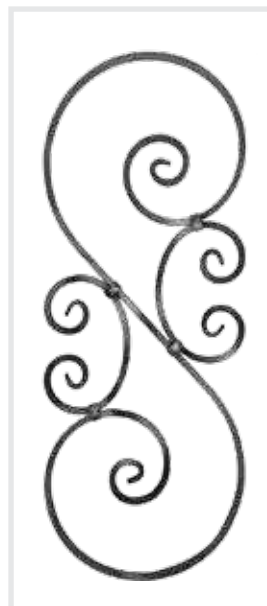

▶M-39  
H.900 x L.370mm  
∅12 - 14  
∅12 - 14

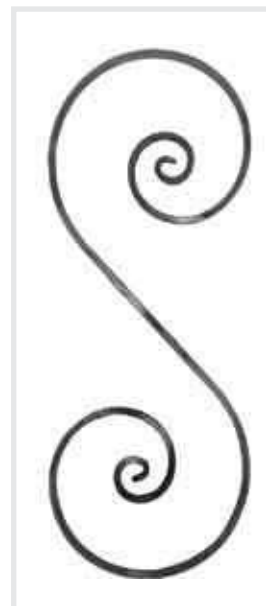

▶M-40  
H.900 x L.350mm  
∅12 - 14  
∅12 - 14



► Μοτίφ διακοσμητικά  
Decorative motifs

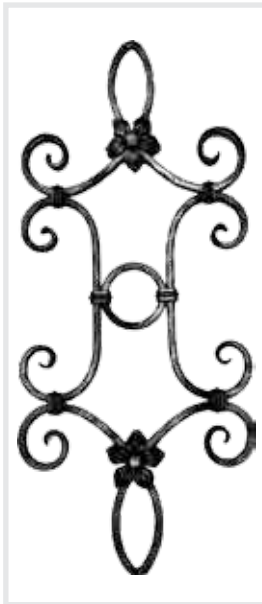

► M-41  
H.800 x L.360mm  
Ø12

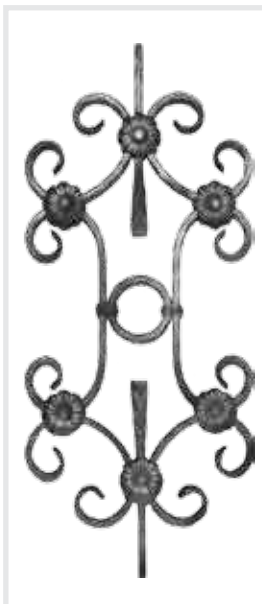

► M-41/2  
H.800 x L.380mm  
Ø12

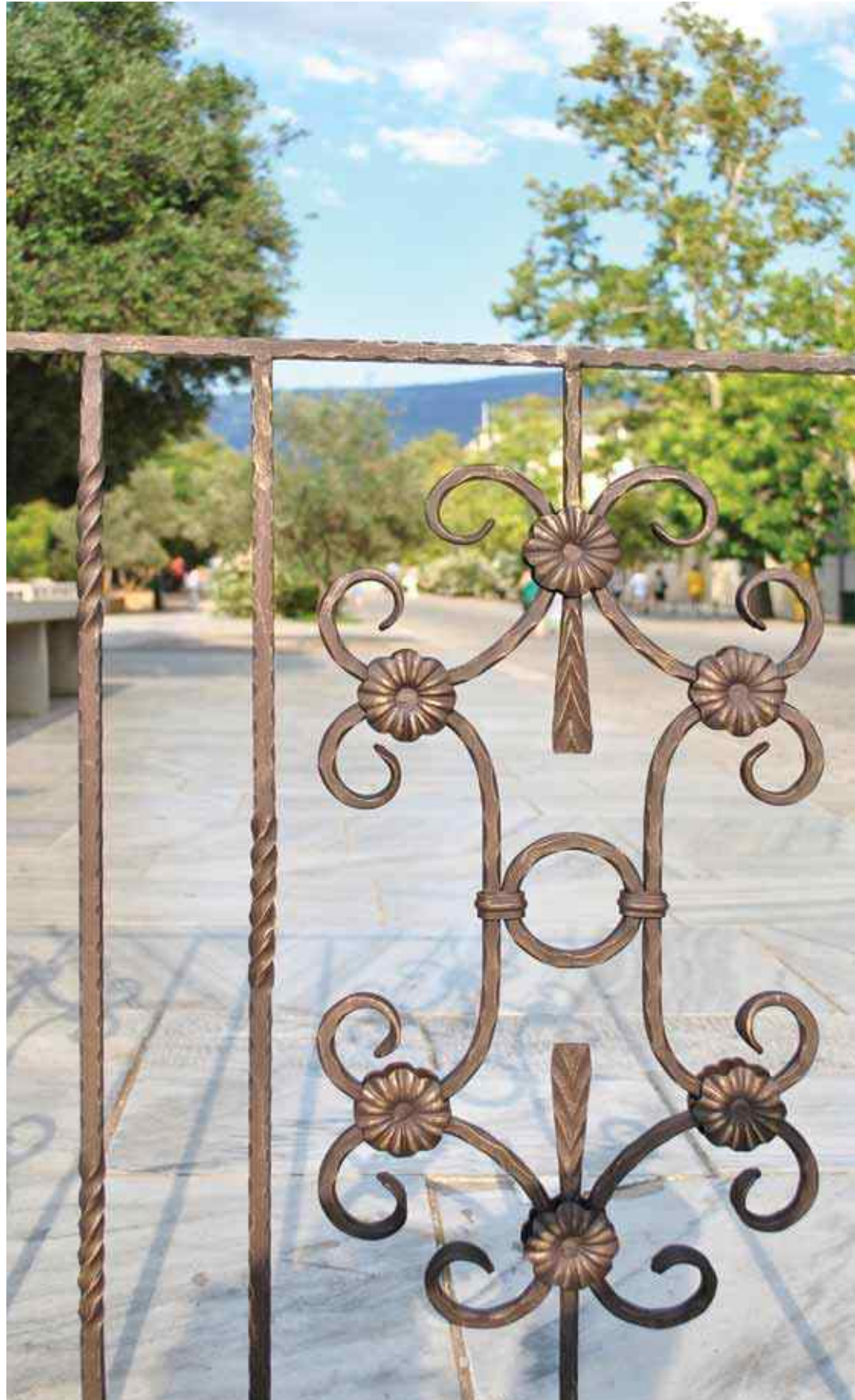

►► Μοτίφ διακοσμητικά  
Decorative motifs



►M-42  
H.550 x L.550mm  
Ø12



►M-43  
H.520 x L.430mm  
Ø12

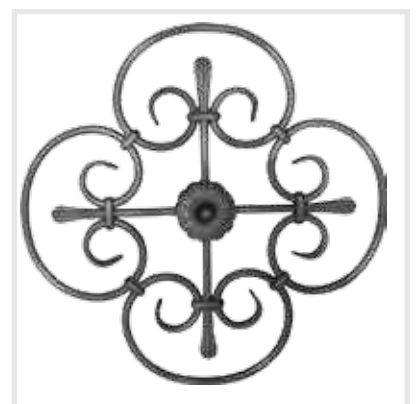

►M-44  
H.570 x L.570mm  
Ø14

▶▶ Μοτίφ διακοσμητικά  
Decorative motifs



▶M-45  
H.450 x L.450mm  
∅14 x 5

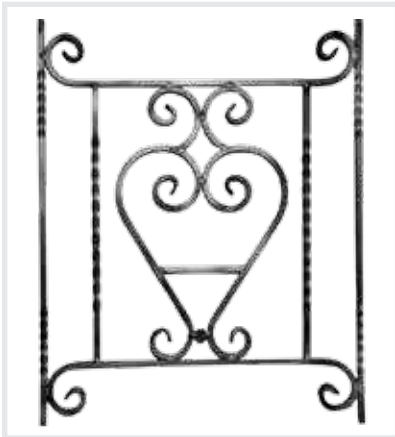

▶M-46  
H.800 x L.620mm  
∅12  
\*Ειδικές διαστάσεις  
κατόπιν παραγγελίας



▶M-47  
H.750 x L.380mm  
∅12

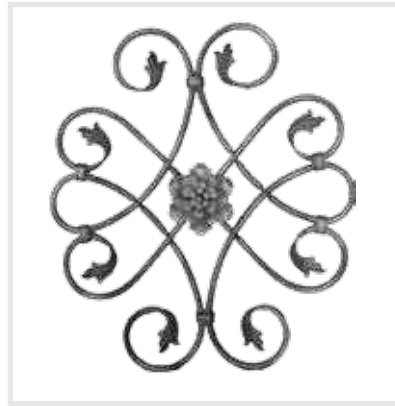

▶M-48  
H.580 x L.510mm  
∅12



▶M-49  
H.480 x L.400mm  
∅16 X 8



▶▶ Μοτίφ διακοσμητικά  
Decorative motifs

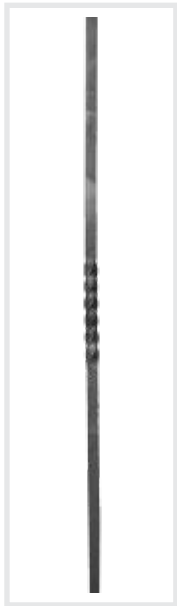

▶M-51  
H.800mm  
∅12



▶M-51B  
H.800mm  
∅12



▶M-52  
H.800mm  
∅12

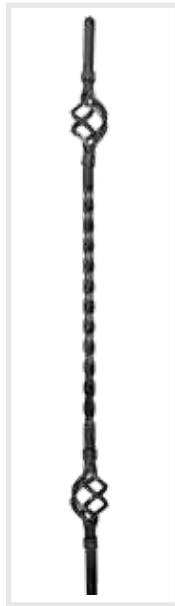

▶M-52B  
H.800mm  
∅12

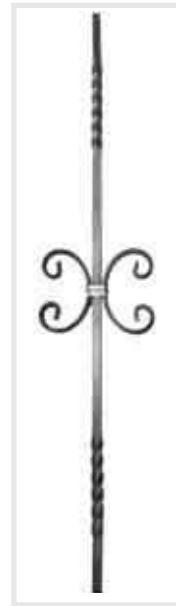

▶M-53  
H800xL150mm  
∅12



▶M-53B  
H800xL150mm  
∅12



▶M-54  
H800xL190mm  
∅12



▶M-54B  
H800xL190mm  
∅12



▶M-55  
H800xL150mm  
∅12



▶M-55B  
H800xL150mm  
∅12



▶▶ Μοτίφ διακοσμητικά  
Decorative motifs



▶M-56  
H.800xL.90mm  
∅12



▶M-57  
H.800xL.130mm  
∅12

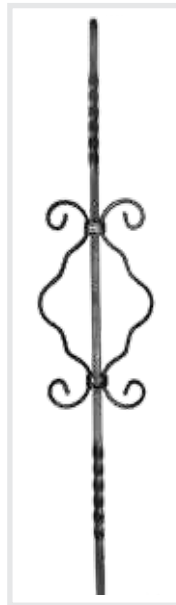

▶M-58  
H.800xL.150mm  
∅12



▶M-58B  
H.800xL.150mm  
∅12

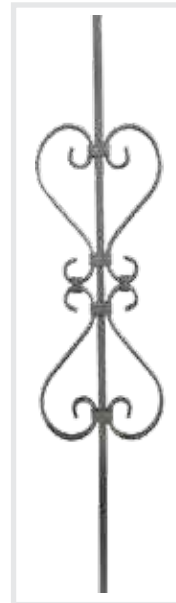

▶M-59  
H.800xL.170mm  
∅12

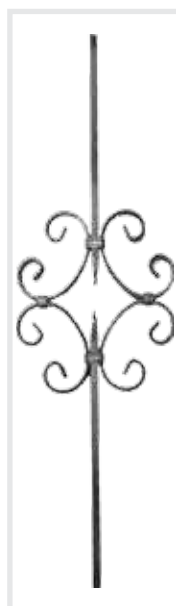

▶M-60  
H.800xL.240mm  
∅12

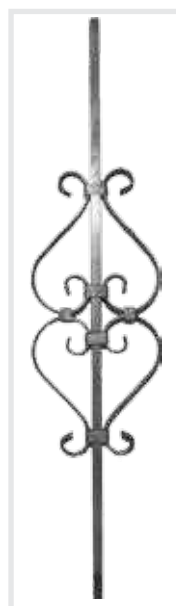

▶M-61  
H.800xL.170mm  
∅12



▶M-62  
H.800xL.200mm  
∅12

▶▶ Μοτίφ διακοσμητικά  
Decorative motifs



▶M-63  
H.800L.150mm  
Ø12

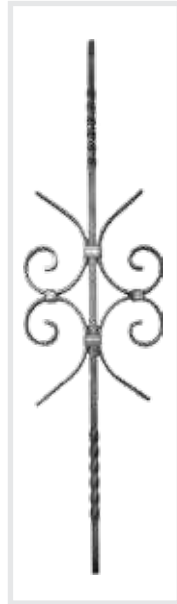

▶M-64  
H.800L.310mm  
Ø12



▶M-65  
H.870 x L.310mm  
Ø12



▶M-65B  
H.800 x L.310mm  
Ø12



▶M-66  
H.800 x L.240mm  
Ø12



▶M-66B  
H.800 x L.240mm  
Ø12





▶▶ Μοτίφ διακοσμητικά  
Decorative motifs

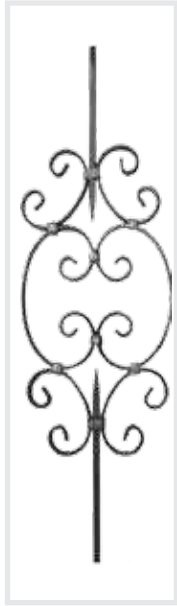

▶M-67  
H.800xL.250mm  
∅12

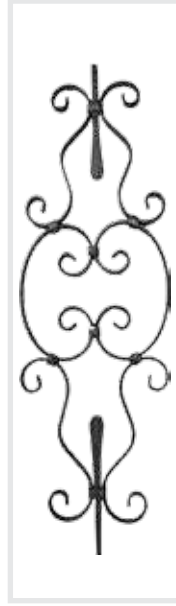

▶M-68  
H.800xL.250mm  
∅12

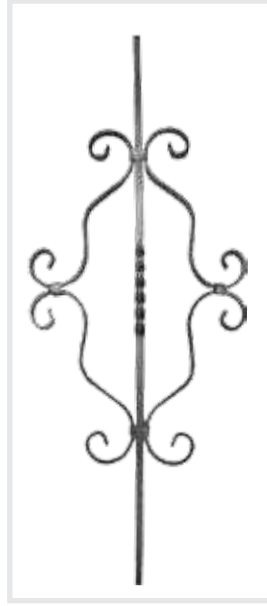

▶M-69  
H.800xL.320mm  
∅12



▶M-70  
H.800xL.470mm  
∅12

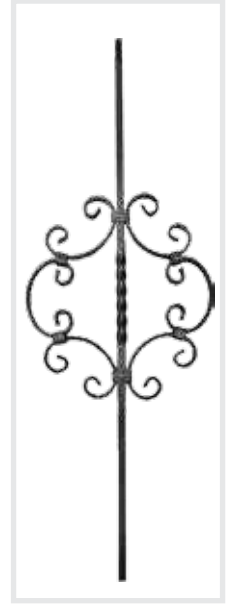

▶M-71  
H.800xL.270mm  
∅12



▶M-72  
H.800xL.270mm  
∅12

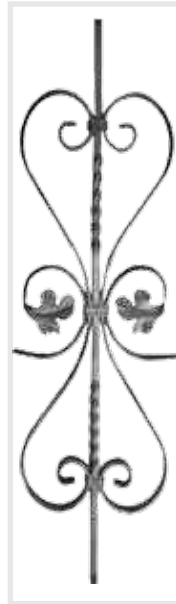

▶M-73  
H.800xL.125mm  
∅12

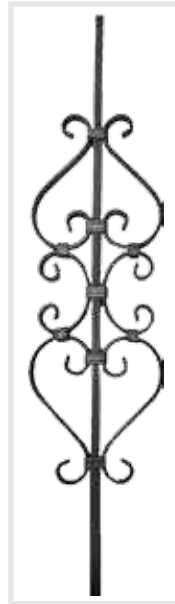

▶M-74  
H.800xL.170mm  
∅12



▶M-75  
H.800xL.190mm  
∅12

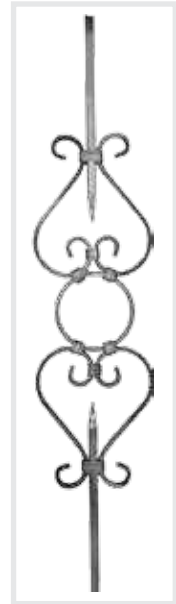

▶M-76  
H.800xL.175mm  
∅12



▶▶ Μοτίφ διακοσμητικά  
Decorative motifs



▶ M-77  
H.800 x L.290mm  
Ø12



▶ M-78  
H.800 x L.310mm  
Ø12



▶ M-79  
H.800 x L.180mm  
Ø12



▶ M-80  
H.800 x L.180mm  
Ø12

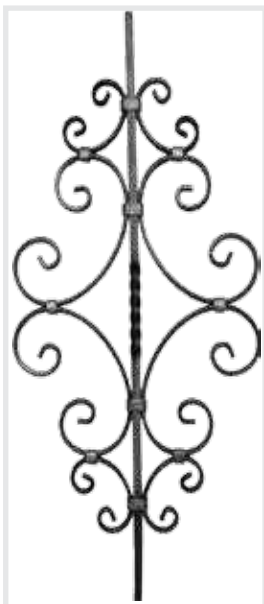

▶ M-81  
H.800 x L.270mm  
Ø12

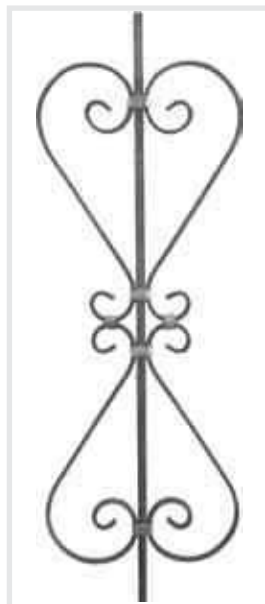

▶ M-82  
H.800 x L.70mm  
Ø12

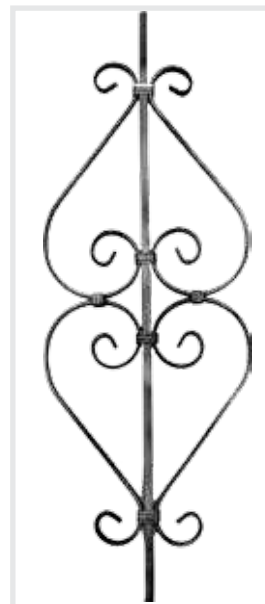

▶ M-83  
H.800 x L.270mm  
Ø12



▶ M-84  
H.800 x L.300mm  
Ø12



▶M-85  
H.250 x L.250mm  
∅20 x 4



▶M-86  
H.250 x L.250mm  
∅8



▶M-87  
H.250 x L.250mm  
∅8



▶M-88  
H.250 x L.250mm  
∅8

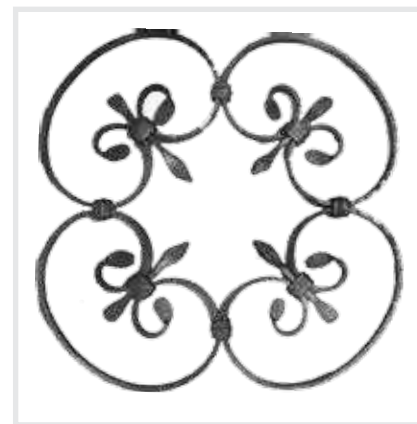

▶M-89  
H.380 x L.380mm  
∅10 x 5

▶▶ Μοτίφ διακοσμητικά  
Decorative motifs



▶M-90  
H.800 x L.410mm  
Ø14

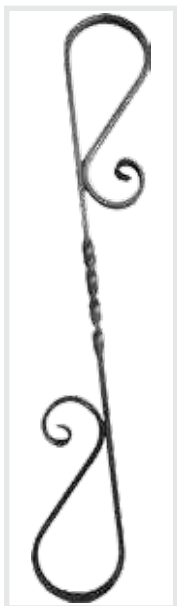

▶M-91  
H.800xL.120mm  
Ø14



▶M-92  
H.800xL.150mm  
Ø14





▶M-93  
L.800mm  
∅12  
∅14



▶M-93B  
L.800mm  
∅12  
∅14

▶ Μοτίφ διακοσμητικά  
Decorative motifs



▶M-109  
H800xL170mm  
∅ 12



▶M-110  
H800xL110mm  
∅ 14



▶M-111  
H800xL190mm  
∅ 16 x 8



▶M-112  
H.800xL.230mm  
∅ 12  
∅ 14







▶▶ Μοτίφ διακοσμητικά  
Decorative motifs



▶M-1001  
H.800xL.150mm  
Ø12



▶M-1002  
H.800xL.120mm  
Ø8 (2)



▶M-1003  
H.800mm  
Ø8 (2)



▶M-1004  
H.800mm  
Ø8 (2)



▶M-1005  
H.800xL.110mm  
Ø8 (2)



▶M-1006  
H.800xL.70mm  
Ø8 (2)



▶M-1007  
H.800xL.125mm  
Ø8 (2)



▶ Μοτίφ διακοσμητικά  
Decorative motifs



▶ M-1010  
H.800xL.170mm  
Ø12

▶▶ Μοτίφ διακοσμητικά  
Decorative motifs



▶ MT-8  
H.370 x L.880mm  
∅16 x 8



▶▶ Μοτίφ διακοσμητικά  
Decorative motifs

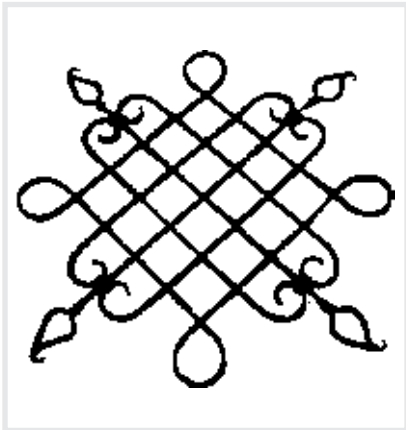

▶ MT-2  
H.830 x L.830mm  
Ø12



▶ MT-3  
H.420 x L.420mm  
Ø12

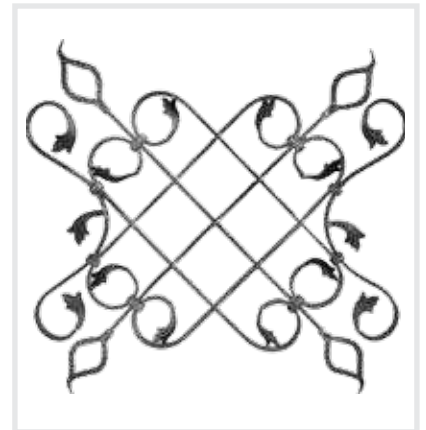

▶ MT-4  
H.640 x L.670mm  
⊂16 x 8

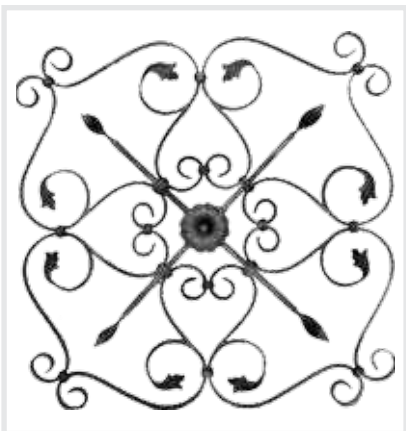

▶ MT-5  
H.700 x L.700mm  
⊂12 x 6

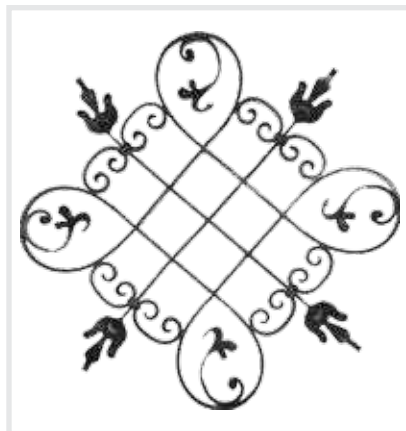

▶ MT-6  
H.870 x L.870mm  
⊂16 x 8



▶ MT-7  
H.780 x L.780mm  
Ø12

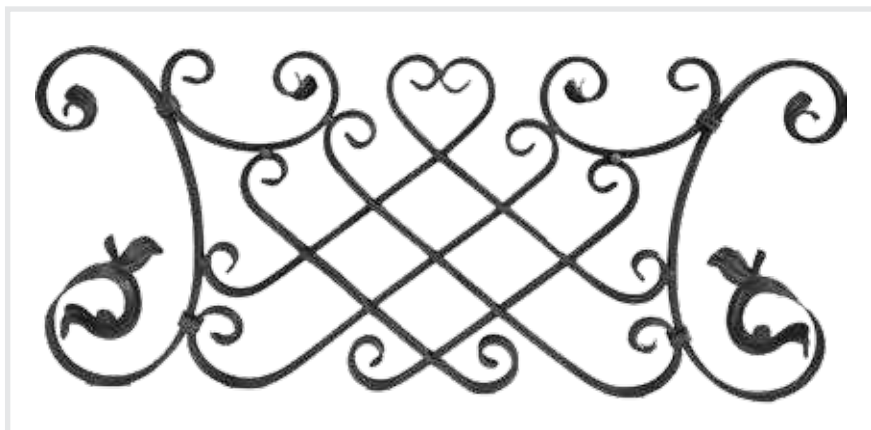

▶ MT-8  
H.370 x L.880mm  
⊂16 x 8

▶▶ Μοτίφ διακοσμητικά  
Decorative motifs

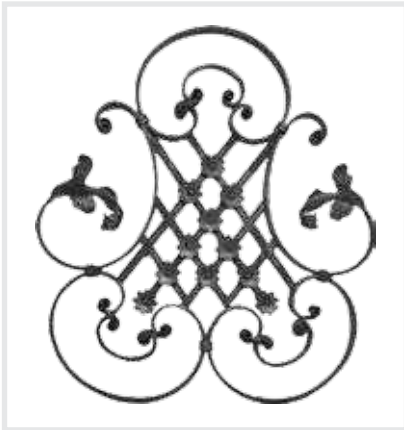

▶MT-10  
H.710 x L.640mm  
⌀16 x 8



▶▶ Μοτίφ διακοσμητικά  
Decorative motifs



MT-12/1  
H.550 x L.750mm  
Ø12



MT-12/2  
H.550 x L.750mm  
Ø12



▶▶ Μοτίφ διακοσμητικά  
Decorative motifs



**MT-13/1**  
H.740 x L.320mm  
∅16 x 8



**MT-13/2**  
H.740 x L.320mm  
∅16 x 8



**MT-14/1**  
H.870 x L.380mm  
∅16 x 8



**MT-14/2**  
H.870 x L.380mm  
∅16 x 8



**MT-15/1**  
H.940 x L.500mm  
∅12

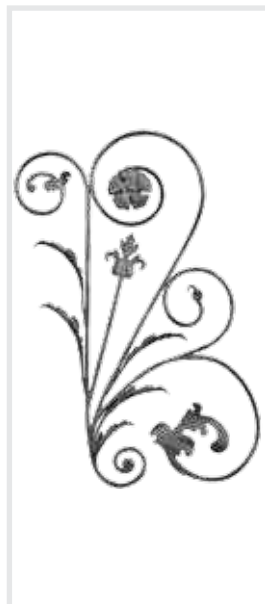

**MT-15/2**  
H.940 x L.500mm  
∅12



**MT-16/1**  
H.1000 x L.600mm  
∅12



**MT-16/2**  
H.1000 x L.600mm  
∅12







▶MT-17  
H.700 x L.300mm  
⊃16 x 8



▶MT-21  
H.800 x L.270mm  
∅8

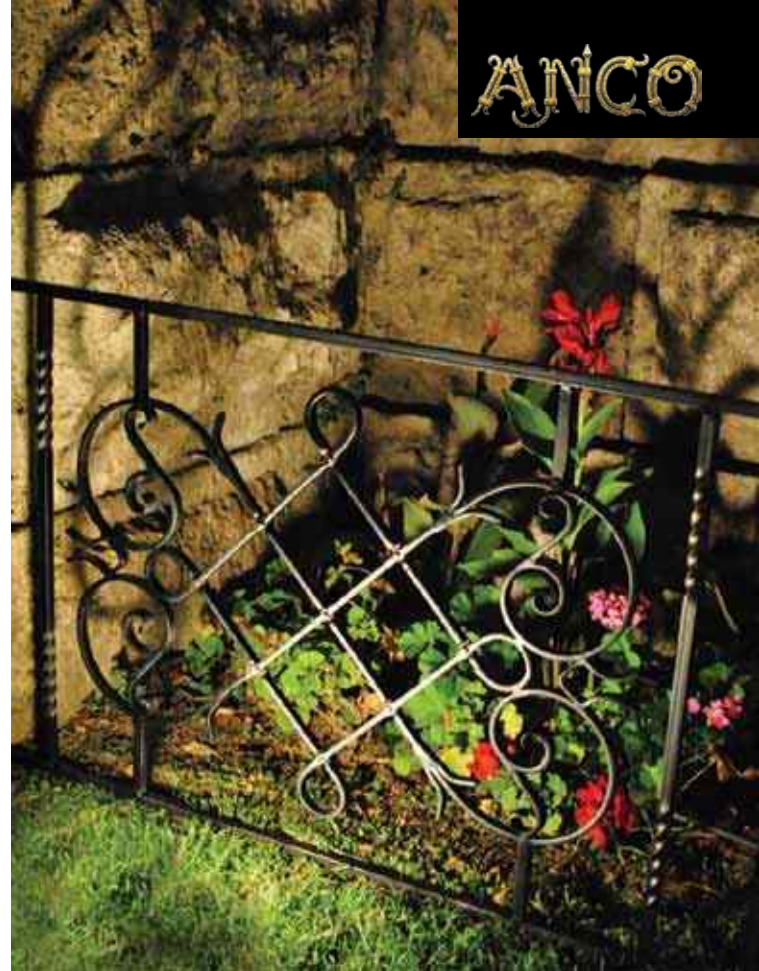

▶MT-19  
H.800 x L.530mm  
⊃16 x 8



▶MT-20  
H.800 x L.530mm  
∅12

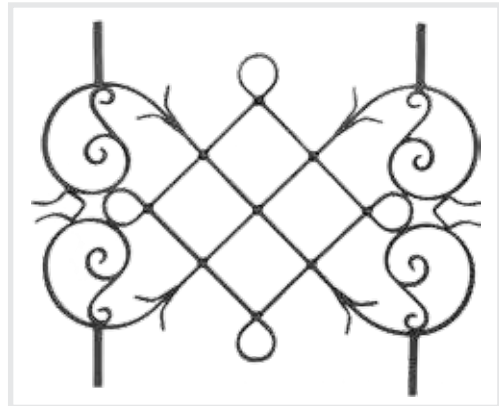

▶MT-24  
H.700 x L.860mm  
⊃16 x 8

▶MT-24B \*με πριτσίνι  
H.700 x L.860mm  
⊃12 x 6

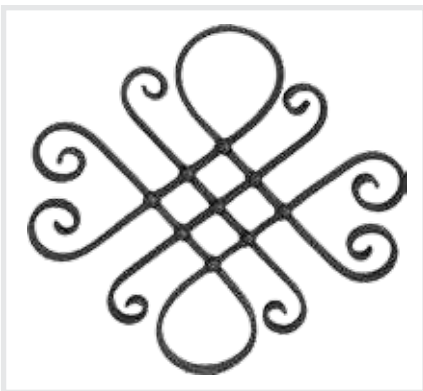

▶MT-22  
H.410 x L.400mm  
⊃16 x 8

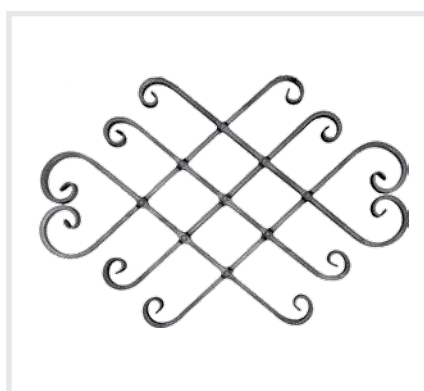

▶MT-23  
H.580 x L.440mm  
⊃16 x 8



▶MT-25  
H.575 x L.400mm  
⊃16 x 8



▶▶ Μοτίφ διακοσμητικά  
Decorative motifs

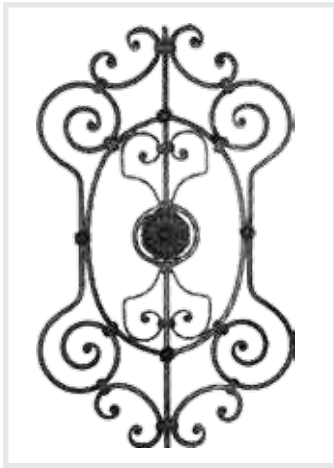

▶MT-30  
H.800 x L.480mm  
⌒16 x 8

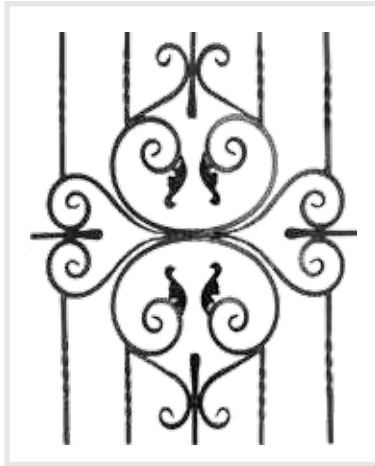

▶MT-31  
H.800 x L.700mm  
⌒16 x 8

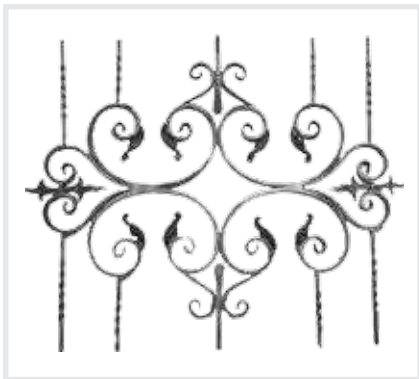

▶MT-32  
H.800 x L.1020mm  
⌒16 x 8



▶MT-33  
H.600 x L.600mm  
⌒16 x 8



▶MT-35  
H.640 x L.1040mm  
⌒16 x 8



▶MT-36  
H.770 x L.840mm  
⌒16 x 8



▶▶ Μοτίφ διακοσμητικά  
Decorative motifs



▶MT-40  
H.800xL.130mm  
∅16 x 8

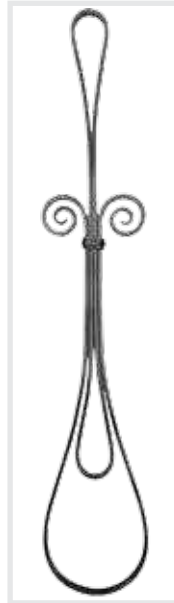

▶MT-41  
H.800xL.140mm  
∅12 x 6



▶MT-42  
H.800xL.200mm  
∅12





▶ Μοτίφ διακοσμητικά  
Decorative motifs



▶MT-52  
H.900 x L.200mm



▶MT-52/B  
H.1000 x L.290mm







M-1009  
H.800xL.70mm  
Ø14

▶▶ Μοτίφ διακοσμητικά  
Decorative motifs



▶MT-54  
H.800xL.50mm  
Ø14



▶MT-55  
H.800xL.50mm  
Ø14

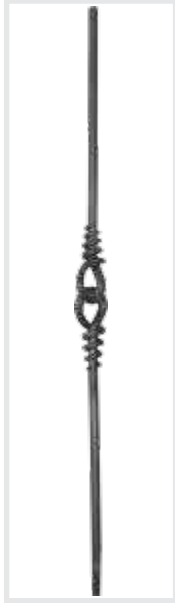

▶MT-56  
H.800xL.50mm  
Ø14

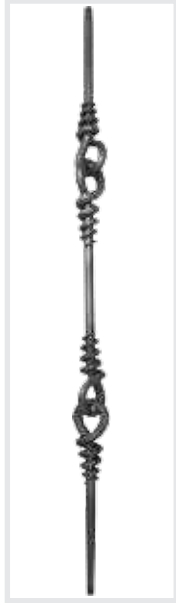

▶MT-57  
H.800xL.50mm  
Ø14

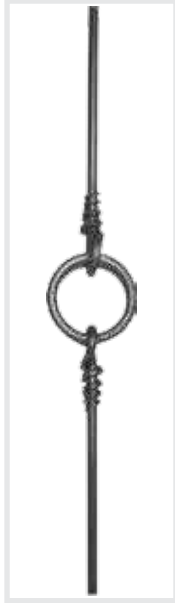

▶MT-58  
H.830xL.130mm  
Ø14

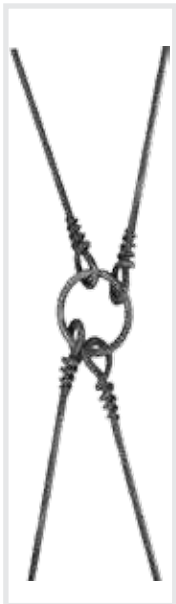

▶MT-59  
H.1000xL.300mm  
Ø14



▶MT-60  
H.800xL.90mm  
Ø14



▶ Μοτίφ διακοσμητικά  
Decorative motifs

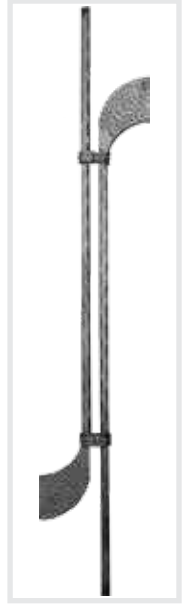

▶MT-61  
H.800xL.117mm  
Ø12

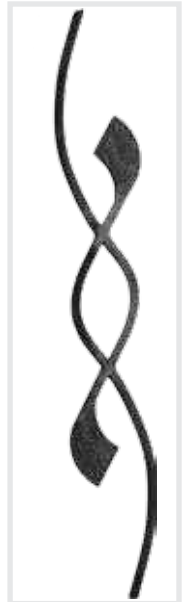

▶MT-62  
H.800xL.110mm  
Ø12

▶▶ Μοτίφ διακοσμητικά  
Decorative motifs



▶▶ MT-63/1  
H800xL130mm  
∅12

▶▶ MT-63/2  
H800xL120mm  
∅12



▶▶ MT-63/3  
H.800xL.120mm  
∅14





▶▶ Μοτίφ διακοσμητικά  
Decorative motifs



▶MT-64  
H.1055xL.800mm  
⌀ 25 x 8



▶MT-65  
H.855xL.800mm  
⌀ 25 x 8





▶▶ Μοτίφ διακοσμητικά  
Decorative motifs



▶MT-66  
H800xL170mm  
Ø 12



▶MT-67  
H800xL140mm  
Ø 12



▶MT-68  
H800xL110mm  
Ø 12



▶MT-69  
H800xL90mm  
Ø 12



▶MT-70  
H800xL150mm  
Ø 12

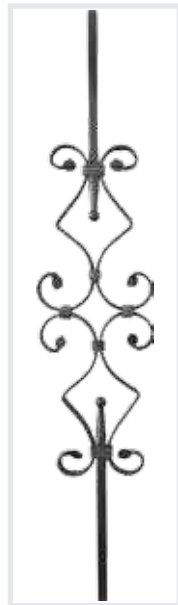

▶MT-71  
H800xL160mm  
Ø 12



▶MT-72  
H.800xL.220mm  
Ø 12



▶MT-73  
H800xL110mm  
Ø 12

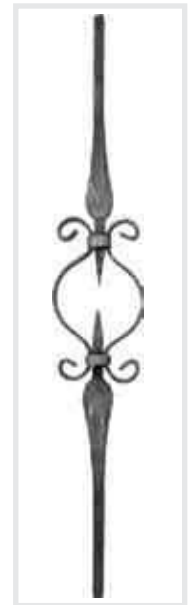

▶MT-74  
H800xL110mm  
Ø 12



▶▶ Παραδείγματα περιφραξης  
 Fences samples



▶E-200

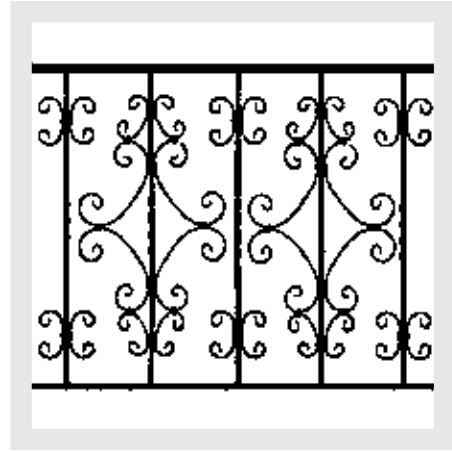

▶E-201

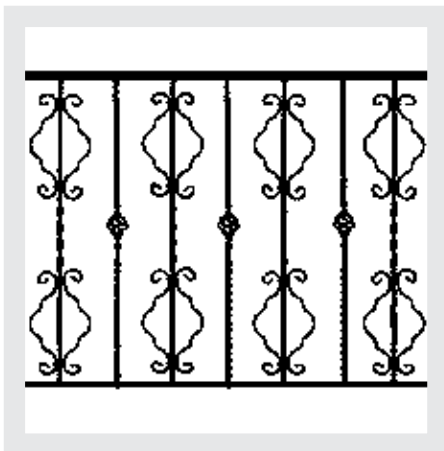

▶E-202

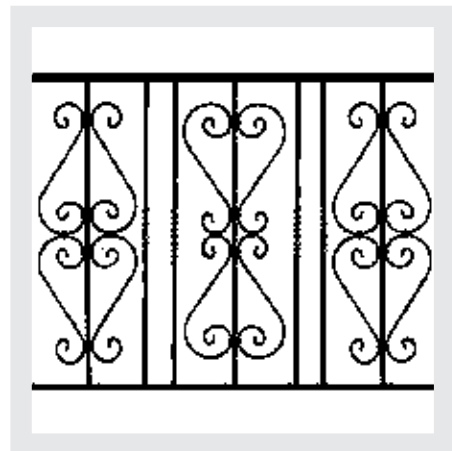

▶E-203



▶E-204



▶E-205

▶▶ Παραδείγματα περιφραξης  
 Fences samples

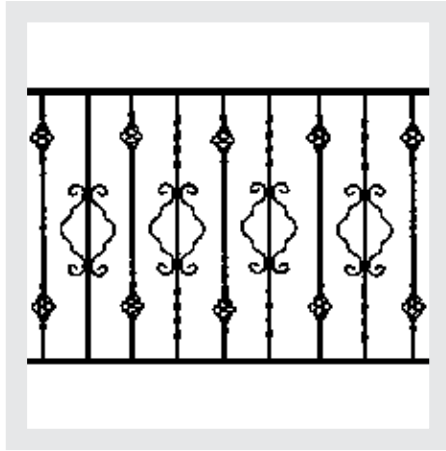

▶E-206



▶E-207

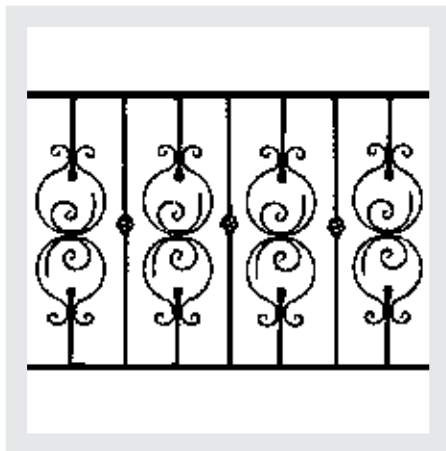

▶E-208



▶E-209

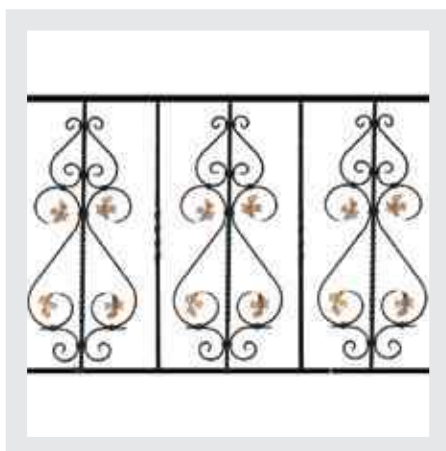

▶E-210



▶E-211

▶▶ Παραδείγματα περιφραξης  
 Fences samples



▶E-212

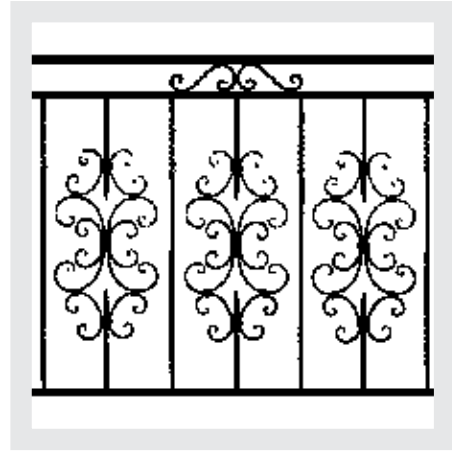

▶E-213

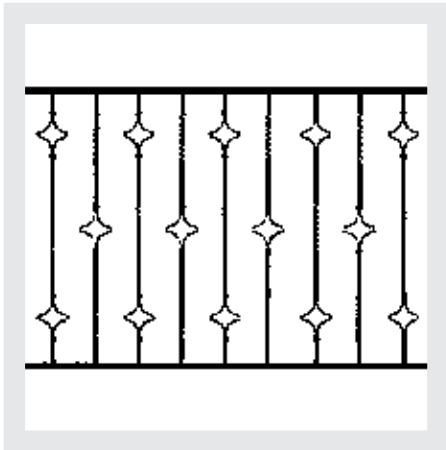

▶E-214

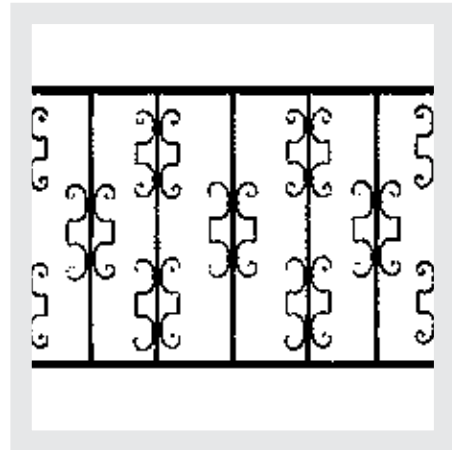

▶E-215

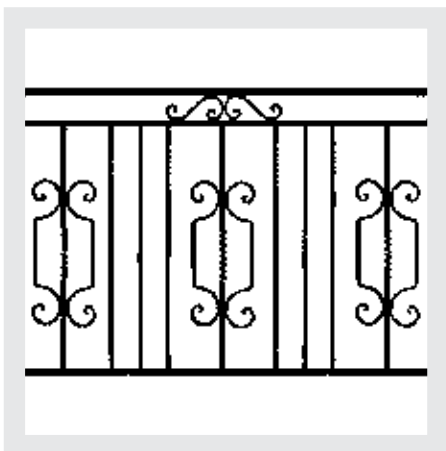

▶E-216

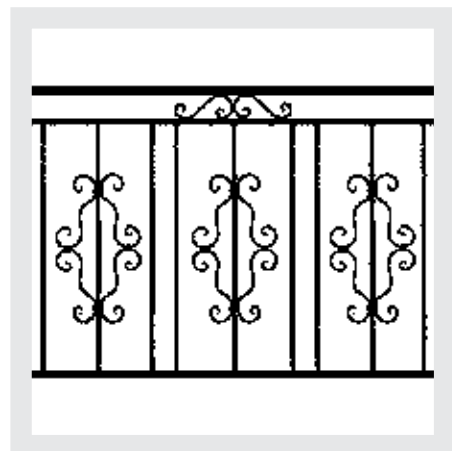

▶E-217

▶▶ Παραδείγματα περιφραξης  
 Fences samples

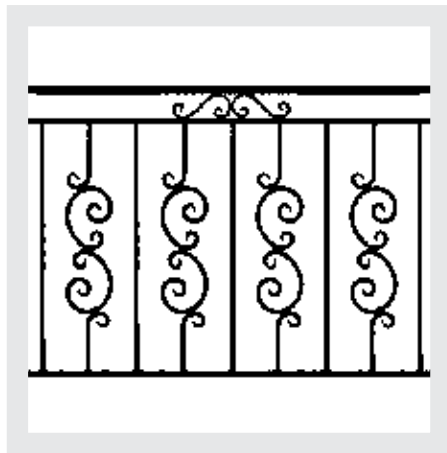

▶E-218

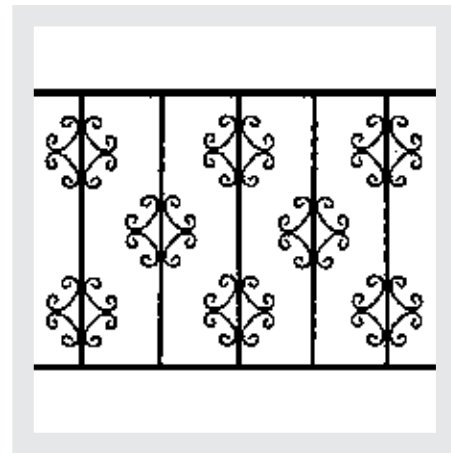

▶E-219

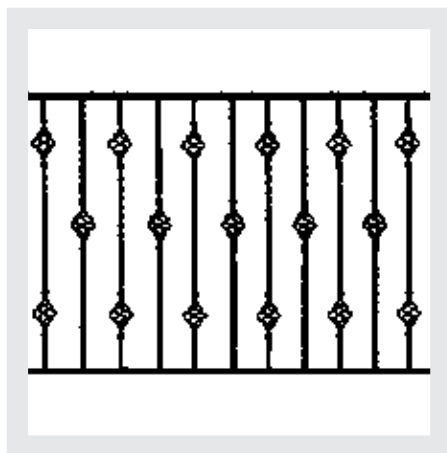

▶E-220

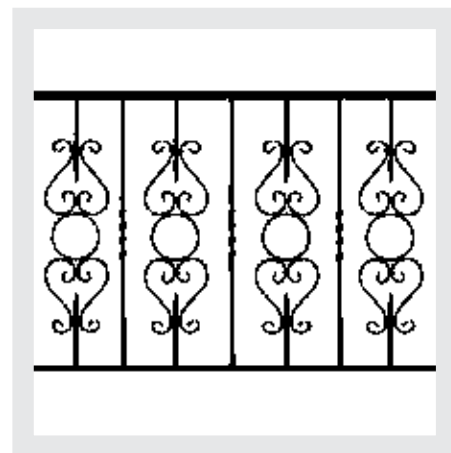

▶E-221

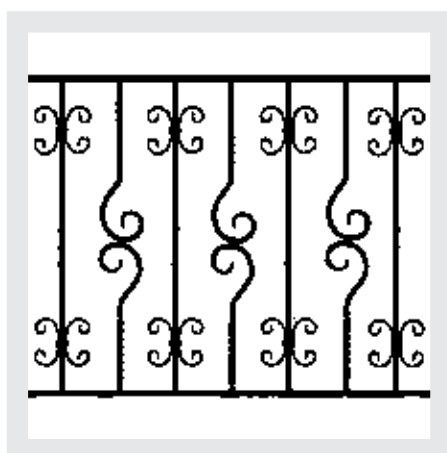

▶E-222



▶E-223



►► Κολόνες σφυρήλατες  
 Forged posts

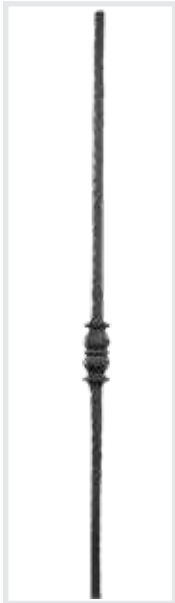

►No 2  
 H.1200mm  
 Ø20

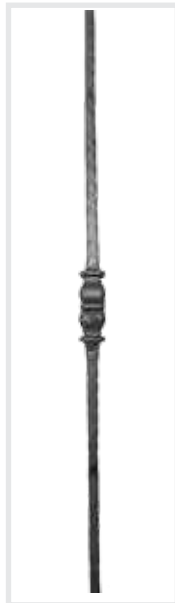

►No 3  
 H.1200mm  
 Ø25

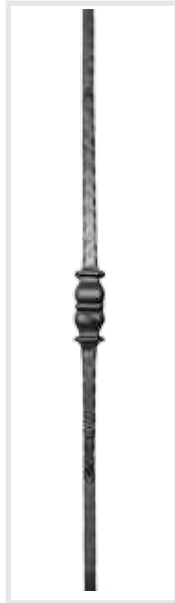

►No 4  
 H.1200mm  
 Ø30



►No 5  
 H.1200mm  
 Ø25



►No 6  
 H.1200mm  
 Ø25



►No 7  
 H.1200mm  
 Ø25

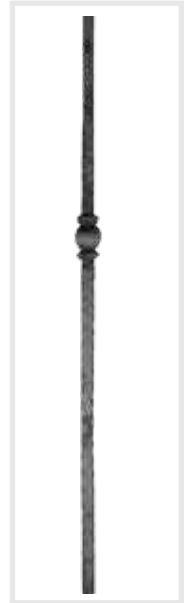

►No 8  
 H.1200mm  
 Ø25

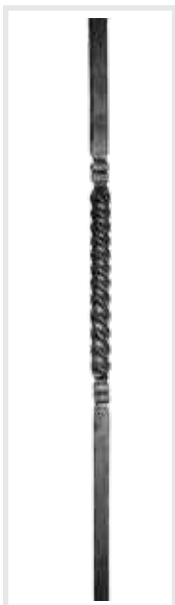

►No 9  
 H.1200mm  
 Ø25



►No 10  
 H.1200mm  
 Ø30



►No 11  
 H.1200mm  
 Ø30



►No 12  
 H.1200mm  
 Ø25



►No 13  
 H.1300mm  
 Ø25



►No 14  
 H.1300mm  
 Ø50

►► Σκάλες εσωτερικού χώρου  
Interior stairs



►M-41  
H.800xL.140mm  
∅12 x 6



►No 8  
H.1200mm  
∅25

▶▶ Σκάλες εσωτερικού χώρου  
Interior stairs



▶MT-56  
H.800 x L.50mm  
Ø14

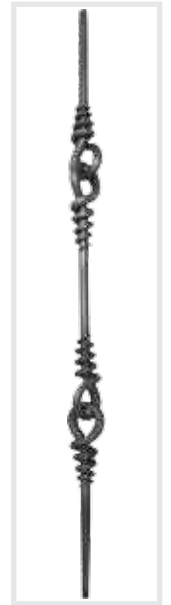

▶MT-57  
H.800 x L.50mm  
Ø14



▶No 7  
H.1200mm  
Ø 25



▶▶ Σκάλες εσωτερικού χώρου  
Interior stairs



▶MT-64  
H.1055xL.800mm  
∅25 x 8

▶▶ Σκάλες εσωτερικού χώρου  
Interior stairs



▶M-106

H.800mm

∅12

∅14



▶M-106B

H.800mm

∅12

∅14



▶No. 8

H.1200mm

∅25

▶▶ Σκάλες εσωτερικού χώρου  
Interior stairs

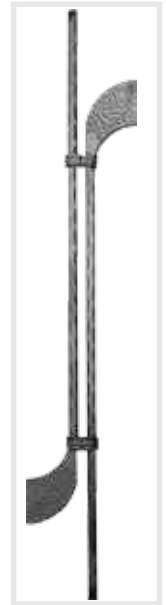

▶MT-61  
H.800xL.117mm  
Ø12



▶No 4  
H.1200mm  
Ø25

▶▶ Σκάλες εσωτερικού χώρου  
Interior stairs



▶MT-40  
H.800xL.130mm  
∅16 x 8



▶No 6  
H.1200mm  
∅25

▶▶ Σκάλες εσωτερικού χώρου  
Interior stairs



▶M-114  
H.800mm  
Ø14

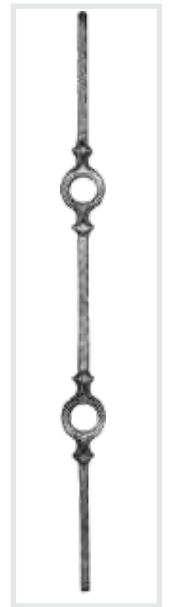

▶M-114B  
H.800mm  
Ø14



▶No 6  
H.1200mm  
Ø25

▶▶ Σκάλες εσωτερικού χώρου  
Interior stairs

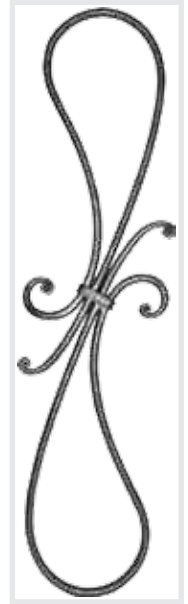

▶MT-42  
H.800xL.200mm  
∅12

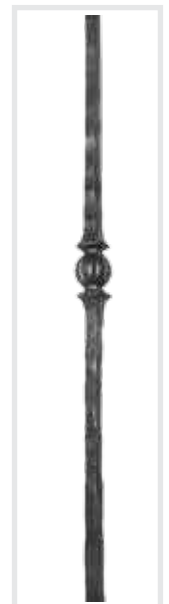

▶No 6  
H.1200mm  
∅25

▶▶ Σκάλες εσωτερικού χώρου  
Interior stairs



▶MT-36  
H.640xL.1040mm  
∅16 x 8

▶▶ Σκάλες εσωτερικού χώρου  
Interior stairs



▶M-63  
H.800mm x L.150mm  
∅12



▶No 10  
H.1200mm  
∅30





►► Μοτίφ σωληνωτά  
Ornamental motifs

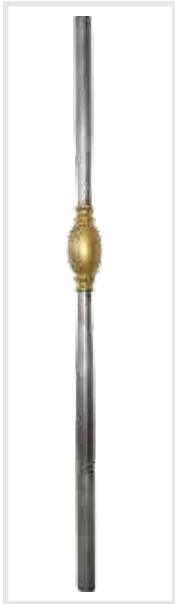

►ΚΣ-001  
H.1200mm  
Ø40

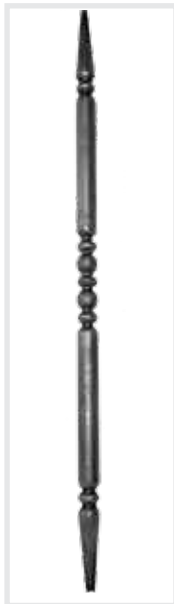

►Σ-001  
H.900mm  
Ø32



►Σ-002  
H.900mm  
Ø42

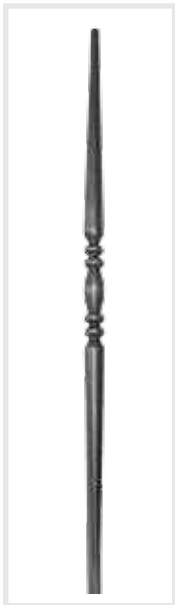

►Σ-003  
H.900mm  
Ø32



►Σ-004  
H.900mm  
Ø42

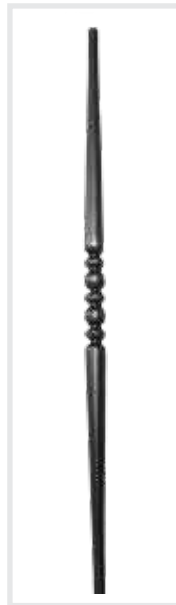

►Σ-005  
H.900mm  
Ø42

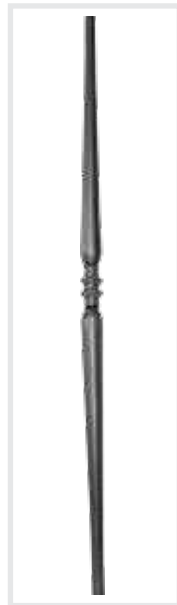

►Σ-006  
H.900mm  
Ø32





# ▶▶ Κουπαστές - Λάμες διακοσμητικές

## Decorative handrails



ΛΑΜΑ ΠΟΜΠΕ  
ΔΙΓΡΑΜΜΗ  
L.3000mm  
⌀40 x 11



ΛΑΜΑ ΠΟΜΠΕ  
ΔΙΓΡΑΜΜΗ  
L.3000mm  
⌀50 x 14



ΛΑΜΑ ΠΟΜΠΕ  
ΔΙΓΡΑΜΜΗ  
L.3000mm  
⌀60 x 16



ΛΑΜΑ ΛΟΥΛΟΥΔΙ  
L.3000mm  
⌀40 x 8



ΛΑΜΑ ΑΠΛΗ  
L.4000mm  
⌀25 x 6  
L.3000mm  
⌀40 x 8



ΛΑΜΑ ΠΟΜΠΕ  
L.3000mm  
⌀30 x 8



ΛΑΜΑ ΠΟΜΠΕ  
L.3000mm  
⌀40 x 8

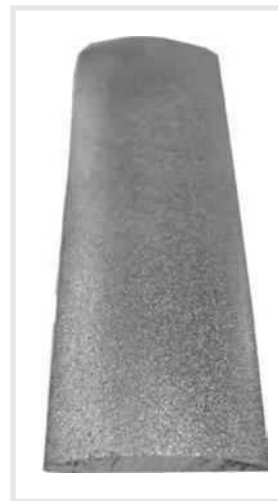

ΛΑΜΑ ΠΟΜΠΕ  
L.3000mm  
⌀50 x 10



►► Τελειώματα κουπαστής  
Handrail finishes



► ΔΙΓΡΑΜΜΟ  
⊂ 40 x 11



► ΔΙΓΡΑΜΜΟ  
⊂ 50 x 14



► ΔΙΓΡΑΜΜΟ  
⊂ 60 x 16



► ΑΠΛΟ  
⊂ 25 x 6  
⊂ 40 x 8



► ΛΟΥΛΟΥΔΙ  
⊂ 40 x 8



► ΑΓΩΣΤΟΜΕ  
⊂ 30 x 8



► ΑΓΩΣΤΟΜΕ  
⊂ 40 x 8



► ΑΓΩΣΤΟΜΕ  
⊂ 50 x 10



► ΤΕΛΕΙΩΜΑ  
ΛΟΥΛΟΥΔΙ  
⊂ 40 x 8



► ΤΕΛΕΙΩΜΑ ΠΟΜΠΕ  
ΔΙΓΡΑΜΜΟ  
⊂ 40 x 11  
⊂ 50 x 14  
⊂ 60 x 16



► ΤΕΛΕΙΩΜΑ ΠΟΜΠΕ  
⊂ 30 x 8  
⊂ 40 x 8  
⊂ 50 x 10

▶▶ Λάμες κουρμαριστές  
Curved handrails



- ▶.2000mm
- ⤿25 x 6
- ⤿30 x 6
- ⤿30 x 8
- ⤿40 x 8



- ▶.2000mm
- ⤿25 x 6



- ▶.2000mm
- ⤿40 x 8

# ▶▶ Διάτρητες βέργες Drilled bars



H.6000mm



H.6000mm

## ΔΙΑΤΡΗΤΕΣ ΛΑΜΕΣ

ΔΙΑΤΟΜΗ	ΤΡΥΠΑ
30 x 8	∅12
30 x 8	∅14
30 x 8	∅16
40 x 8	∅12
40 x 8	∅14
40 x 8	∅16
50 x 8	∅14
50 x 8	∅16
50 x 8	∅18
50 x 8	∅20

## ΔΙΑΤΡΗΤΟ ΠΙ

### ΔΙΑΤΟΜΗ ΤΡΥΠΑ



H.6000mm

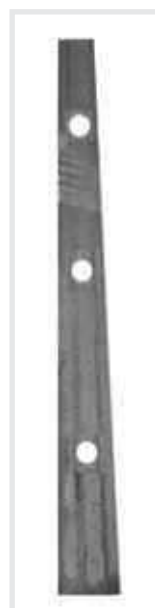

H.6000mm

30 x 15	∅12
30 x 15	∅14
30 x 15	∅16
30 x 15	∅12
30 x 15	∅14
30 x 15	∅16
40 x 20	∅14
40 x 20	∅16
40 x 20	∅18
40 x 20	∅20
40 x 20	∅14
40 x 20	∅16
40 x 20	∅18
40 x 20	∅20

# ▶▶ Διάτρητες βέργες Drilled bars



L.2000mm



L.2000mm



L.2000mm  
∅14

∅	Από κέντρο σε κέντρο	Τρύπα ανά Βέργα
14mm	140mm	14
16mm	150mm	13
18mm	160mm	12
20mm	170mm	11
25mm	180mm	10
30mm	200mm	9

∅	Από κέντρο σε κέντρο	Τρύπα ανά Βέργα
14mm	140mm	14
16mm	150mm	13
20mm	170mm	11



▶▶ Σφυρήλατες βέργες  
Κοιλοδοκοί  
Forged bars - Hollow bars



ΚΟΙΛΟΔΟΚΟΣ  
ΟΡΘΟΓΩΝΙΟΣ

H6000mm/H3000mm

40 x 30 80 x 30

50 x 30 60 x 40

60 x 30 80 x 40

70 x 30 100 x 40



ΚΟΙΛΟΔΟΚΟΣ  
ΤΕΤΡΑΓΩΝΟΣ

H6000mm/H3000mm

25 x 25 40 x 40

30 x 30 50 x 50

# ►► Σφυρήλατες βέργες Κοιλοδοκοί

Forged bars - Hollow bars



## ► ΚΑΡΣΟΥΡΗΛΑΤΟ

H.3000mm

12		18
14		20
16		



## ► ΣΤΡΟΓΓΥΛΟ

H.3000mm

12		18
14		20
16		

## Στρογγυλές διακοσμητικές βέργες



H.3000mm  
Ø16

H.3000mm  
Ø20

H.3000mm  
Ø25

H.3000mm  
Ø30

▶▶ Διακοσμητικά χυτά στοιχεία  
Decorative cast items



**ΜΠΑΛΑ ΟΒΑΛ**

MB-40 40 x 40mm	50
MB-50 50 x 50mm	50
MB-60 60 x 60mm	24
MB-80 80 x 80mm	10
MB-100 100 x 100mm	6



**ΜΠΑΛΑ ΟΒΑΛ  
ΝΕΟΥ ΤΥΠΟΥ**

MB-40 40 x 40mm	40
MB-50 50 x 50mm	40
MB-60 60 x 60mm	25
MB-80 80 x 80mm	12
MB-100 100 x 100mm	7



**ΜΠΑΛΑ ΟΒΑΛ ΜΕ  
ΣΤΡΟΓΥΛΗ ΒΑΣΗ**

MBΣ - Ø42	40
MBΣ - Ø48	40

# ▶▶ Διακοσμητικά χυτά στοιχεία

## Decorative cast items



**ΠΥΡΑΜΙΔΑ**

P-40 40 x 40mm	48
P-50 50 x 50mm	48
P-60 60 x 60mm	24
P-80 80 x 80mm	12
P-100 100 x 100mm	6



**ΠΥΡΑΜΙΔΑ  
ΝΕΟΥ ΤΥΠΟΥ**

P-40 40 x 40mm	90
P-50 50 x 50mm	30
P-60 60 x 60mm	30
P-80 80 x 80mm	10
P-100 100 x 100mm	6



**ΒΑΣΗ  
ΚΟΙΛΟΔΟΚΟΥ**

MR-30 30 x 30mm	80
MR-40 40 x 40mm	80
MR-60 60 x 60mm	18
MR-80 80 x 80mm	12



**ΕΝΔΙΑΜΕΣΟ  
ΔΙΑΚΟΣΜΗΤΙΚΟ**

OR-30 30 x 30mm	50
OR-40 40 x 40mm	40
OR-60 60 x 60mm	20
OR-80 80 x 80mm	10



**ΒΑΣΗ  
ΚΟΙΛΟΔΟΚΟΥ**

ER-12 12 x 12mm	250
ER-14 14 x 14mm	250
ER-16 16 x 16mm	200
ER-20 20 x 20mm	150
ER-25 25 x 25mm	150
ER-30 30 x 30mm	150
ER-40 40 x 40mm	90
ER-50 50 x 50mm	50
ER-60 60 x 60mm	50
ER-80 80 x 80mm	36
ER-100 100 x 100mm	20



**ΜΠΑΛΑ  
ΚΟΙΛΟΔΟΚΟΥ**

MK-30 30 x 30mm	100
MK-40 40 x 40mm	50
MK-50 50 x 50mm	50
MK-60 60 x 60mm	24
MK-80 80 x 80mm	10
MK-100 100 x 100mm	6



**ΜΠΑΛΑΚΟΙΛΟΔΟΚΟΥ  
ΝΕΟΥ ΤΥΠΟΥ**

MK-30 30 x 30mm	100
MK-40 40 x 40mm	50
MK-50 50 x 50mm	32
MK-60 60 x 60mm	20
MK-80 80 x 80mm	8
MK-100 100 x 100mm	6



**ΜΠΑΛΑΚΟΙΛΟΔΟΚΟΥ  
ΣΤΡΟΓΓΥΛΗ**

MKS - $\varnothing$ 42	50
MKS - $\varnothing$ 48	32
MKS - $\varnothing$ 60	20



ΜΠΑΛΕΣΣΙΔΗΡΟΥ  
ΜΑΣΙΦ

∅20 ∅50  
∅25 ∅60  
∅30 ∅80  
∅35 ∅100  
∅40



▶ ΜΠΑΛΕΣΣΙΔΗΡΟΥΜΕ  
ΜΙΣΗΔΙΑΤΡΗΣΗ

ΜΔ-3 ∅30  
∅14  
ΜΔ-5 ∅40  
∅16



▶ ΜΠΑΛΕΣΣΙΔΗΡΟΥΜΕ  
ΜΙΣΗΔΙΑΤΡΗΣΗ

ΜΔ-4 ∅30  
∅14



ΜΠΑΛΕΣΣΙΔΗΡΟΥ  
ΔΙΑΤΡΗΤΕΣ

ΜΔ-1 ∅40  
∅14



▶ ΜΠΑΛΕΣΣΙΔΗΡΟΥ  
ΔΙΑΤΡΗΤΕΣ

ΜΔ-2 ∅40  
∅16



▶ ΜΠΙΛΙΑΜΕΓΑΛΗΜΑ

∅20 ∅12  
∅25 ∅12  
∅30 ∅12  
∅30 ∅14  
∅35 ∅14  
∅40 ∅14

# ▶▶ Διακοσμητικά χυτά στοιχεία

## Decorative cast items

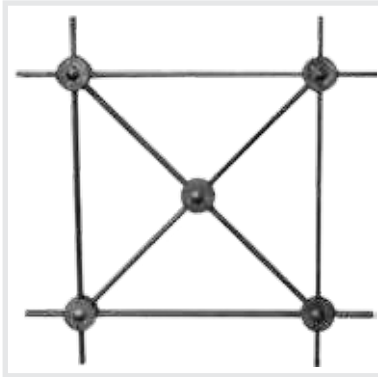

### ΧΙΑΣΤΙΑΛΟΥΜΙΝΙΟΥ

- ∅ ∅4 45 χ 45cm
- ∅ ∅4 55 χ 55cm
- ∅ 14 χ 5
- ∅ 16 χ 6
- ∅ 20 χ 6
- ∅ 20 χ 8



### ΧΙΑΣΤΙΑΛΟΥΜΙΝΙΟΥ

- 155mm
- 165mm
- ∅ 12 χ 6
- ∅ 14 χ 5
- ∅ 16 χ 6
- ∅ 20 χ 6
- 📦 150



### ΧΙΑΣΤΙ ΑΠΛΟ

- 155mm
- 165mm
- ∅ 12 χ 6
- ∅ 14 χ 5
- ∅ 16 χ 6
- ∅ 20 χ 6
- 📦 200

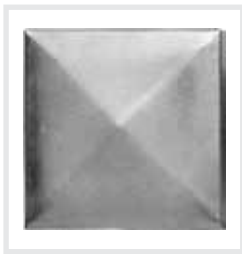

### ΤΑΠΑΤΕΤΡΑΓΩΝΗ

- No 30mm
- No 40mm
- No 50mm
- No 60mm
- No 80mm
- No 100mm



### ΦΟΥΒΑ / kg

- ∅ 33
- ∅ 40
- ∅ 50
- ∅ 60



### ▶ ΒΑΣΗ

- No 12mm
- No 14mm
- No 16mm
- No 20mm



### ΤΑΠΑΣΤΡΟΓΥΛΗ

- No 30mm
- No 40mm
- No 50mm
- No 60mm
- No 80mm
- No 90mm
- No 100mm
- No 30x20mm
- No 40x20mm
- No 50x30mm
- No 60x30mm
- No 60x40mm
- No 80x40mm

### ΤΑΠΑΟΡΘΟΓΩΝΙΑ

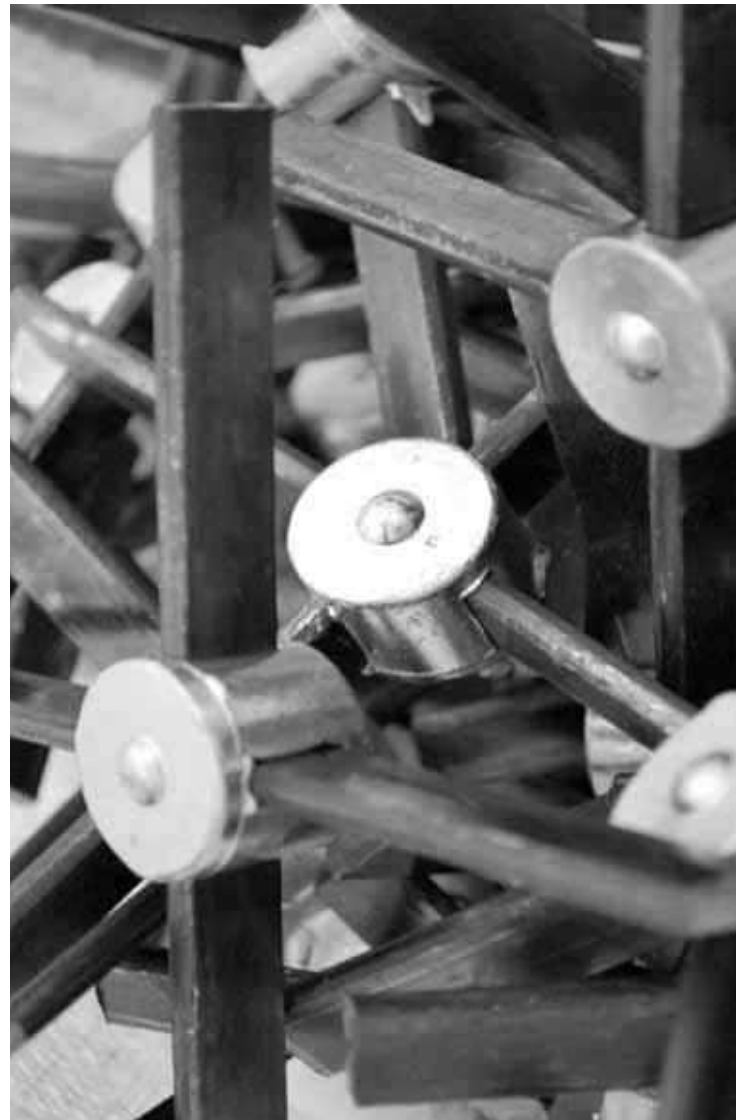



▶ E-20  
H. 150mm  
■ 50



▶ E-24  
H.40 x L.41mm  
■ 100  
∅14



▶ E-25  
H.40 x L.41mm  
∅ 16  
■ 100



▶ E-26  
H.22 x L.44mm  
∅12  
∅14  
■ 100



▶ E-27  
H.22 x L.44mm  
∅12  
∅14  
■ 200



▶ E-28  
H.40 x L.45mm  
∅14  
■ 100



▶ E-29  
H.90 x L.45mm  
∅16  
■ 100



▶ E-30  
H.66 x L.41mm  
∅12  
∅14  
■ 100



▶ E-31  
H.66 x L.41mm  
∅ 16  
■ 100



▶ E-32  
H.50 x L.32mm  
∅14  
■ 100

▶▶ Διακοσμητικά χυτά στοιχεία  
Decorative cast items



▶Z-1  
∅14  
130



▶Z-2  
∅16  
130



▶ZΣ-1  
∅14  
130



▶ZΣ-2  
∅16  
130



▶ZΣ-3  
H.105 x L.80mm  
∅16  
50



▶ZΣ-4  
H.57mm  
∅16  
100



▶ZΣ-5  
∅16  
∅42  
40





▶▶ Διακοσμητικά χυτά στοιχεία  
Decorative cast items



▶PX-21  
∅38  
300



▶PX-24  
∅95  
80



▶PX-22  
∅48  
200



▶PX-25  
H.95 x L.95mm  
50

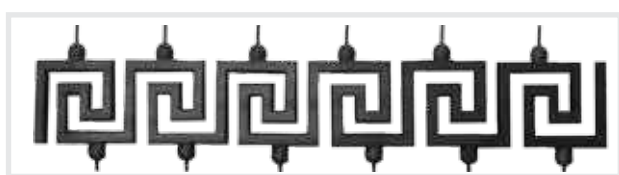

▶MX-3  
H.130 x L.500mm

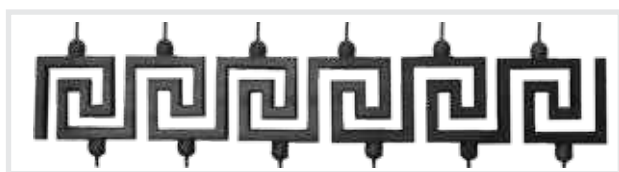

▶MX-3A  
H.130 x L.1000mm



▶PX-23  
∅60  
150



▶MX-30  
∅200  
15



▶MX-31  
H.240 x L.160mm  
20



▶MX-32  
H.340 x L.170mm  
15



ΩΝΙΑ MX-33  
H.100 x L.100mm  
40



▶MX-34  
H.250 x L.100mm  
50



▶MX-1  
H.380 x L.840mm



▶MX-2  
H.230 x L.520mm



▶MX-4  
H.430 x L.190mm

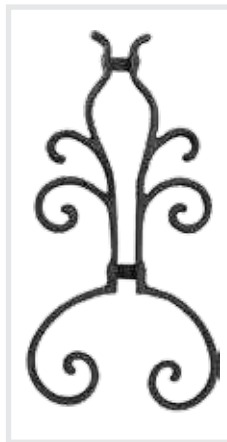

▶MX-5  
H.360 x L.190mm



▶MX-6  
H.190 x L.170mm



▶MX-7  
H.100 x L.130mm



▶MX-8  
H.225 x L.125mm



▶MX-9  
H.220 x L.130mm









▶▶ Διακοσμητικά πόρτας  
Door decorative items

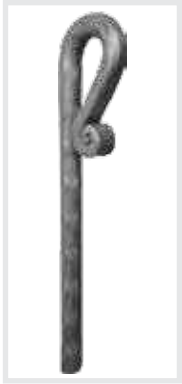

▶ΔΠ-125  
∅12-20



▶ΔΠ-126  
∅12-20



▶ΔΠ-127  
∅12-20



▶ΔΠ-128  
∅40



▶ΔΠ-129  
⌒40 x 11  
⌒50 x 14  
⌒60 x 16



▶ΔΠ-130  
⌒30 x 8  
⌒40 x 8  
⌒50 x 10



▶ΔΠ-131  
⌒25 x 6  
⌒30 x 8  
⌒50 x 8



▶ΔΠ-132  
⌒25 x 6  
⌒30 x 8  
⌒50 x 8



▶ΔΠ-133  
⌒30 x 8  
⌒40 x 8  
⌒50 x 10



▶ΔΠ-134  
⌒30 x 8  
⌒40 x 8  
⌒50 x 8  
⌒60 x 8



▶ΔΠ-135  
⌒30 x 8  
⌒40 x 8  
⌒50 x 8  
⌒60 x 8



▶ΔΠ-136  
⌒25 x 6  
⌒40 x 8  
⌒50 x 8

\*H.800-2000mm









▶▶ Διακοσμητικά κλειδαριάς  
Χειρολαβές  
Decorative lock items - Door knobs

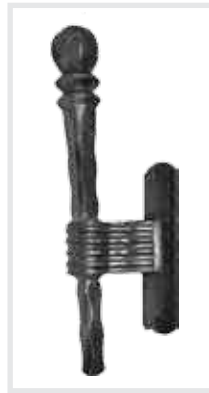

▶ΚΛΣ-14  
H.400mm

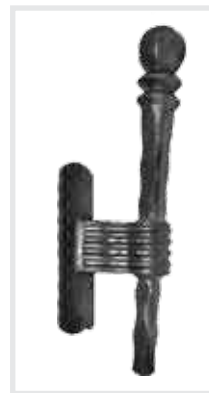

▶ΚΛΣ-15  
H.400mm



▶ΚΛΣ-16  
H.400mm

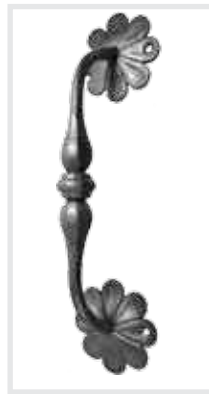

▶ΚΛΣ-17  
H.400mm

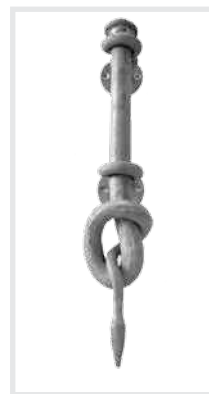

▶ΚΛΣ-18  
H.400mm

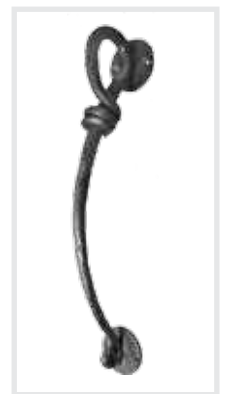

▶ΚΛΣ-19  
H.400mm



ΣΤΗΡΙΓΜΑΣΤ-1  
H.180 x L.70mm



ΣΤΗΡΙΓΜΑΣΤ-2  
H.200 x L.45mm



ΣΤΗΡΙΓΜΑΣΤ-3  
H.165 x L.55mm



ΣΤΗΡΙΓΜΑΣΤ-4  
H.180 x L.70mm

▶▶ Διακοσμητικά κλειδαριάς  
Χειρολαβές  
Decorative lock items - Door knobs



▶ΚΛ-6  
Ø60



▶ΚΛ-7  
Ø60



▶ΚΛ-8  
Ø60



▶ΚΛ-9  
Ø60



▶ΚΛΧ-1  
H.75 x L.145mm



▶ΚΛ-10  
Ø60



▶ΚΛΧ-3  
H.90 x L.110mm



▶ΚΛΧ-4  
H.50 x L.180mm



▶ΚΛ-5/1  
H.305 x L.135mm



▶ΚΛ-5/1  
H.305 x L.135mm



▶ΚΛ-5/2  
H.305 x L.135mm



▶ΚΛ-5/2  
H.305 x L.135mm



▶ΚΛ-1/2  
H.290 x L.160mm

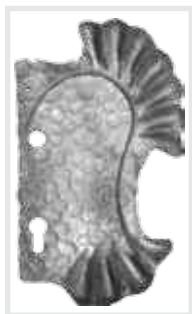

▶ΚΛ-2/2  
H.290 x L.160mm

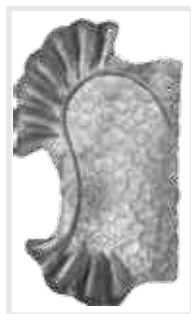

▶ΚΛ-1/1  
H.290 x L.160mm

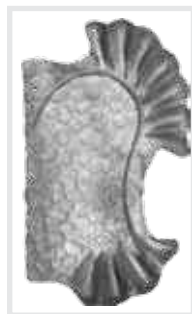

▶ΚΛ-2/1  
H.290 x L.160mm

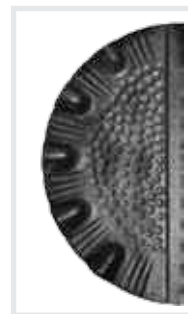

▶ΚΛ-11/1  
H.263 x L.128mm



▶ΚΛ-11/2  
H.263 x L.128mm

►► Φύλλα - Ροζέτες διακοσμητικές  
 Leaves - Decorative rosette



►ΜΛ-1  
 Ø10mm



►ΜΛ-2  
 Ø80mm



►ΜΛ-3  
 Ø60mm



►ΜΛ-4  
 Ø60mm



►ΜΛ-5  
 Ø60mm



►ΜΛ-6  
 Ø70mm



►ΜΛ-7  
 Ø95mm

▶▶ Φύλλα - Ροζέτες διακοσμητικές  
Leaves - Decorative rosette



▶ No 1/1  
H.110xL.40mm



▶ No 1/2  
H.110xL.40mm



▶ No 2/1  
H.80xL.60mm



▶ No 2/2  
H.80xL.60mm



▶ No 3/1  
H.60xL.70mm



▶ No 3/2  
H.60xL.70mm



▶ No 4/1  
H.80xL.45mm



▶ No 4/2  
H.80xL.45mm



▶ No 5/1  
H.130xL.60mm



▶ No 5/2  
H.130xL.60mm



▶ No 6/1  
H.120xL.90mm



▶ No 6/2  
H.120xL.90mm



▶ No 7/1  
H.120xL.90mm



▶ No 7/2  
H.120xL.90mm



▶ No 8  
H.190xL.70mm



▶ No 9  
H.335xL.120mm



▶ No 10  
H.280xL.50mm



▶ No 11  
H.280xL.50mm



▶▶ Διακοσμητικά είδη σπιτιού  
Decorative house items



▶AT-001  
H.700mm



▶AT-002  
H.820mm



▶KΦ-1  
H.150χL.280mm



▶KΦ-2  
H.900 χ L.450mm



▶KΦ-3  
H.400 χ L.380mm  
Ø 8



▶KΦ-5  
H.630 χ L.610mm  
Ø12



# ▶ Πτυσσόμενες πόρτες & παράθυρα ασφαλείας

## Security folding doors & windows

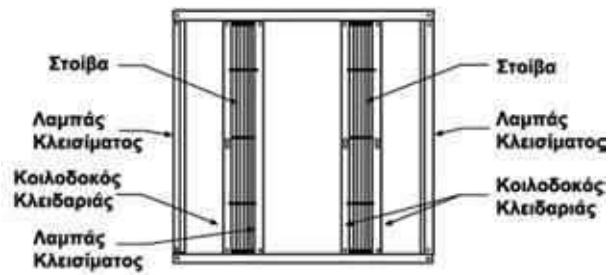

**ΔΙΠΛΟ ΠΛΑΙΣΙΟ FLEXI  
DOUBLE FLEXI**



Επιλέξτε  
το χρώμα  
που ταιριάζει  
στο χώρο σας.







Λαμαρινοειδής τύπος  
Sheet metal type

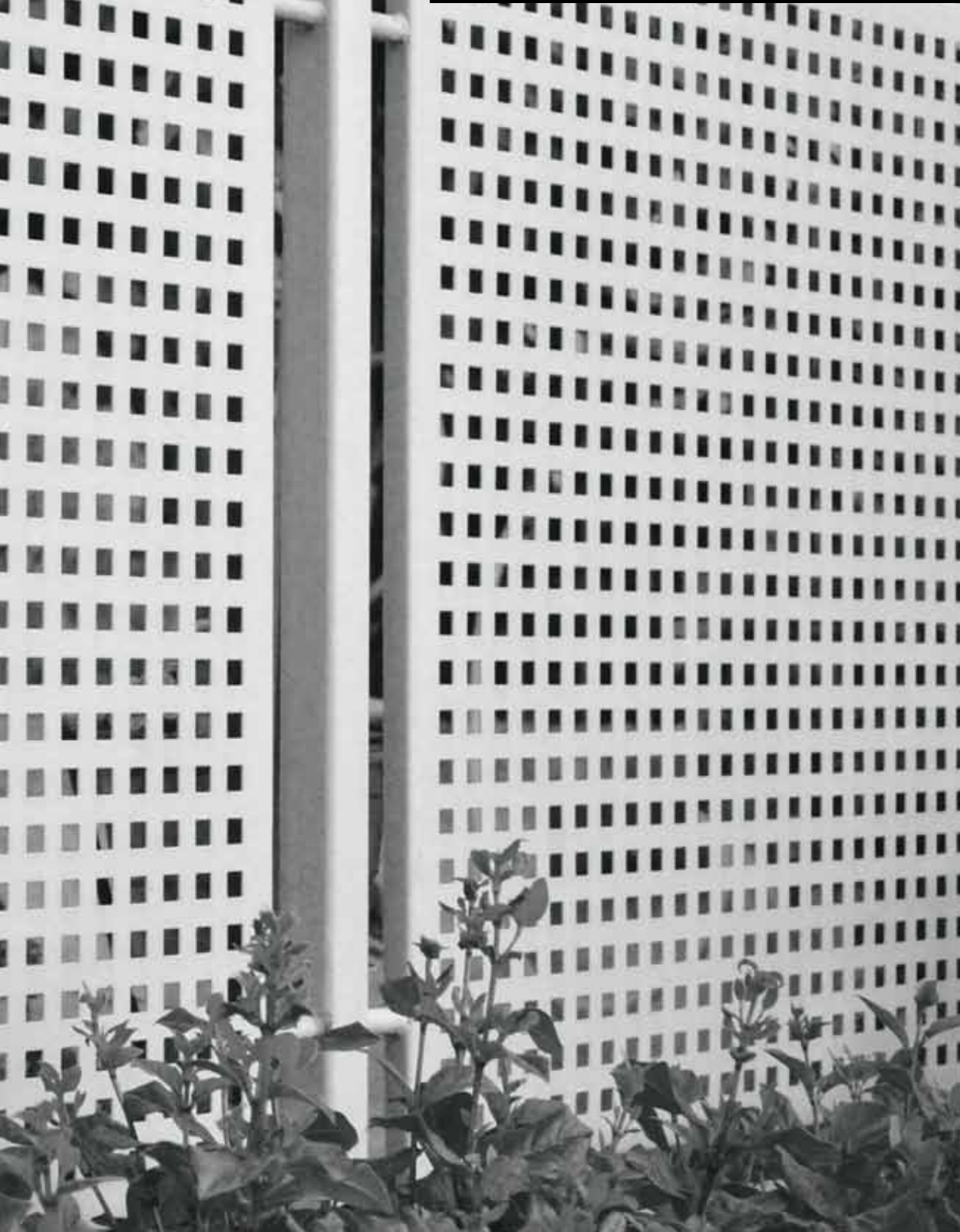



# ▶ Διάτρητες λαμαρίνες

## Perforated metal sheets

### ΦΟΡΜΟΥΛΑ ΔΙΑΤΡΗΣΕΩΝ / PERFORATION FORMULA

ΔΙΑΤΑΞΗ ΟΠΩΝ ARRANGEMENT OF HOLES	ΠΕΡΙΓΡΑΦΗ DESCRIPTION	% ΑΕΡΑΣ % OPEN AREA	ΤΡΥΠΕΣ /m2 HOLES /m2
	R-T	$\frac{R^2 \times 90,69}{T^2}$	$\frac{1.154.700}{T^2}$
	R-U	$\frac{R^2 \times 78,50}{U1 \times U2}$	$\frac{1.000.000}{U1 \times U2}$
	C-U	$\frac{C^2 \times 100}{U1 \times U2}$	$\frac{1.000.000}{U1 \times U2}$
	C - Z1 x Z2	$\frac{C^2 \times 100}{0,5 \times (Z1 \times Z2)}$	$\frac{1.000.000}{0,5 \times (Z1 \times Z2)}$
	LR - Z1 x Z2	$\frac{(R \times L - 0,215R^2) \times 100}{0,5 \times (Z1 \times Z2)}$	$\frac{1.000.000}{0,5 \times (Z1 \times Z2)}$
	LC - Z1 x Z2	$\frac{100 \times L \times C}{0,5 \times (Z1 \times Z2)}$	$\frac{1.000.000}{0,5 \times (Z1 \times Z2)}$

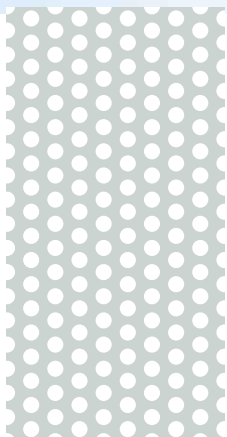

**Χωρίς Περιθώρια**  
Without Margin  
(Perforated all over)

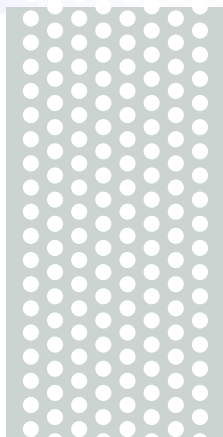

**Περιθώρια κατά μήκος**  
Margins  
(Long sides)

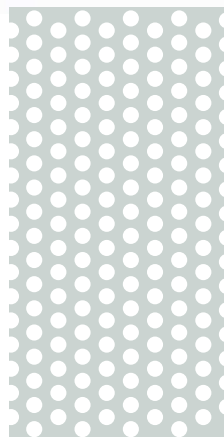

**Περιθώρια κατά πλάτος**  
Margins  
(Short sides)

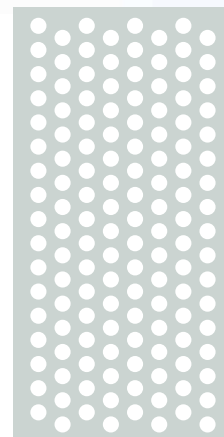

**Με περιθώριο**  
Margins  
(All around)

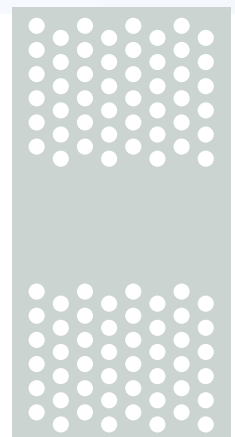

**Τμηματική Διάτρηση**  
Sectional  
Perforation

# ▶ Διάτρητες λαμαρίνες ΣΤΡΟΓΓΥΛΕΣ ΟΠΕΣ / ROUND HOLES

## ΤΡΙΓΩΝΙΚΗ ΔΙΑΤΑΞΗ ΟΠΩΝ TRIANGULAR PITCH

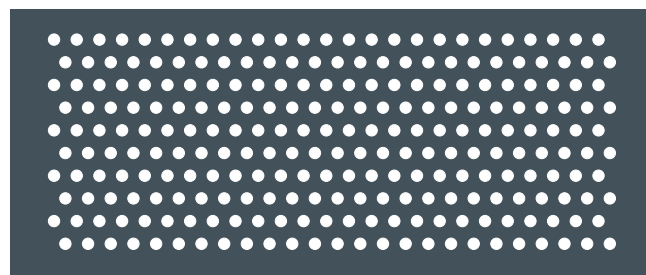
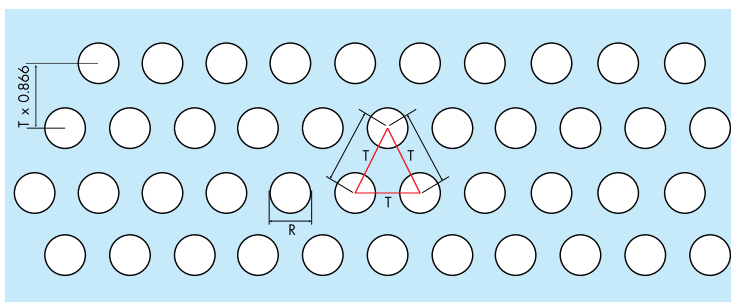

TR0004

No.	R	T	% ΑΕΡΑΣ / OPEN AIR
TR0001	0.50	1.09	19.00
TR0002	0.75	1.50	22.70
TR0003	1.00	2.00	22.70
TR0004	1.50	3.00	22.70
TR0005	2.00	3.50	29.61
TR0006	2.00	5.00	14.51
TR0007	3.00	5.00	32.65
TR0008	3.00	6.25	20.89
TR0009	3.50	6.25	28.44
TR0010	4.00	6.25	37.15
TR0011	4.00	7.50	25.80
TR0012	5.00	7.30	40.31
TR0013	5.00	8.75	29.61
TR0014	6.00	8.75	42.64
TR0015	6.00	10.00	32.65
TR0016	7.00	10.00	44.44
TR0017	8.00	10.00	58.04
TR0018	8.00	12.50	37.15
TR0019	9.00	13.75	38.85
TR0020	10.00	15.00	40.31
TR0021	12.00	17.50	42.64
TR0022	12.00	20.00	32.65
TR0023	14.00	20.00	44.44
TR0024	15.00	21.00	46.27
TR0025	20.00	27.00	49.76
TR0026	25.00	39.00	37.27
TR0027	30.00	35.00	66.63

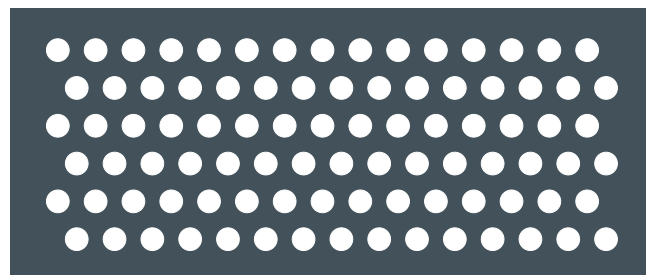

TR0007

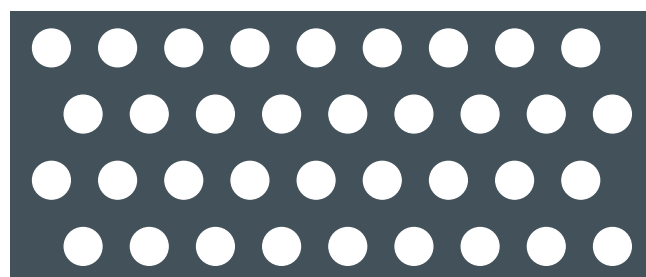

TR0013

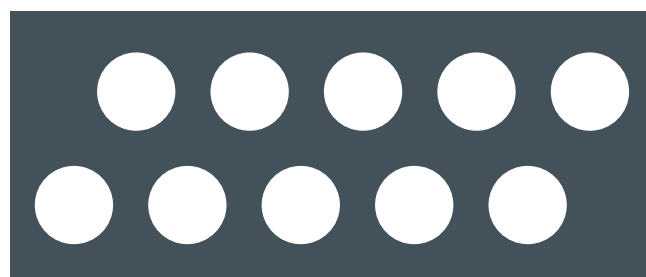

TR0020

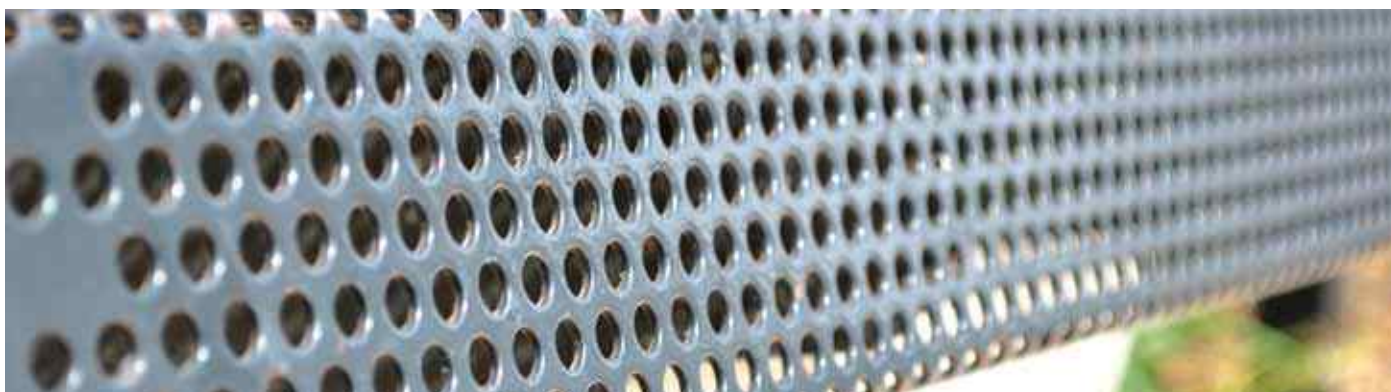

# ▶ Διάτρητες λαμαρίνες ΣΤΡΟΓΓΥΛΕΣ ΟΠΕΣ / ROUND HOLES

ΤΕΤΡΑΓΩΝΗΔΙΑΤΑΞΗ ΟΠΩΝ / SQUARE PITCH

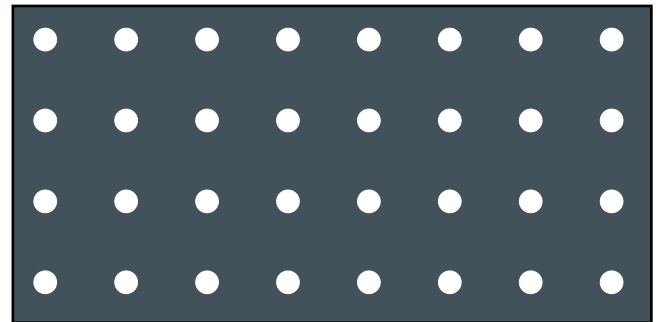
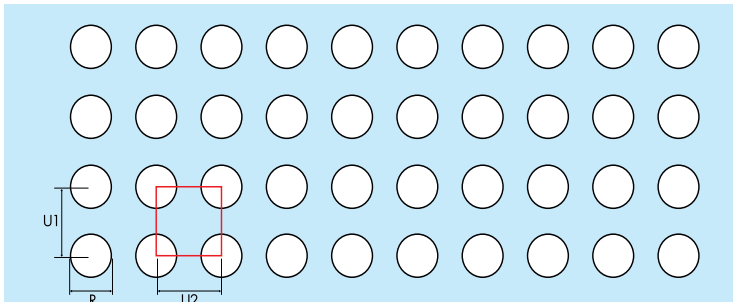

SQ0003

No.	R	UT	% ΑΕΡΑΣ / OPEN AIR
SQ0001	2	8.70	4.15
SQ0002	3	8.30	10.26
SQ0003	3	10.70	6.17
SQ0004	4	10.98	10.42
SQ0005	4	13.00	7.43
SQ0006	4.5	12.50	10.17
SQ0007	5	12.50	12.56
SQ0008	5	15.40	8.28
SQ0009	5.5	13.50	13.03
SQ0010	6	15.38	11.95
SQ0011	6	17.50	9.23
SQ0012	8	17.30	16.79
SQ0013	8	21.63	10.74
SQ0014	10	26.40	11.26
SQ0015	12	30.28	12.33
SQ0016	12	35.15	9.15
SQ0017	14	34.60	12.85
SQ0018	20	40.00	19.63
SQ0019	25	50.00	19.63
SQ0020	30	50.00	28.26
SQ0021	50	64.00	47.91

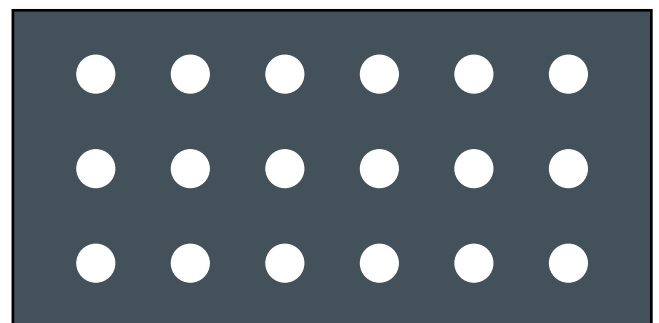

SQ0007

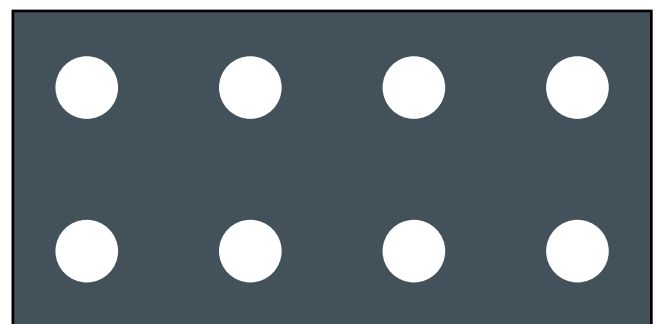

SQ0013

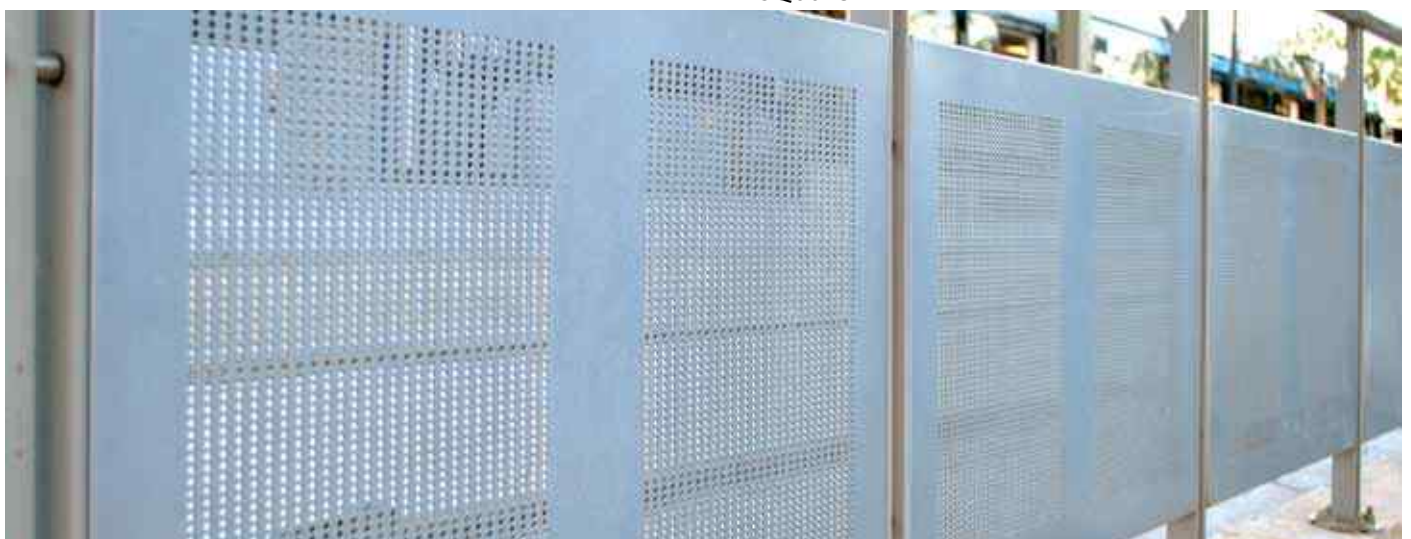

# ▶ Διάτρητες λαμαρίνες ΣΤΡΟΓΓΥΛΕΣ ΟΠΕΣ / ROUND HOLES

## ΔΙΑΤΑΞΗ ΟΠΩΝ ΣΕ Z / STAGGERED PITCH

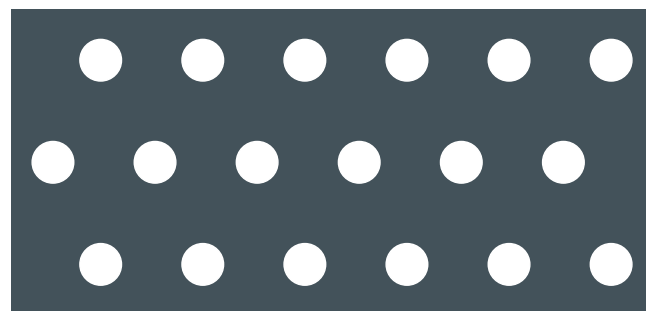
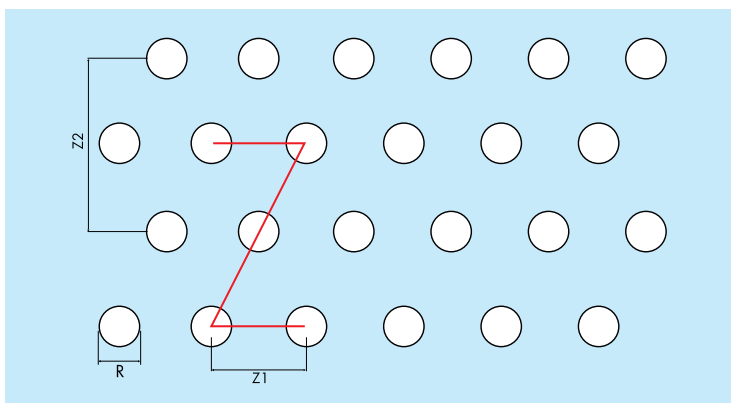

ST0010

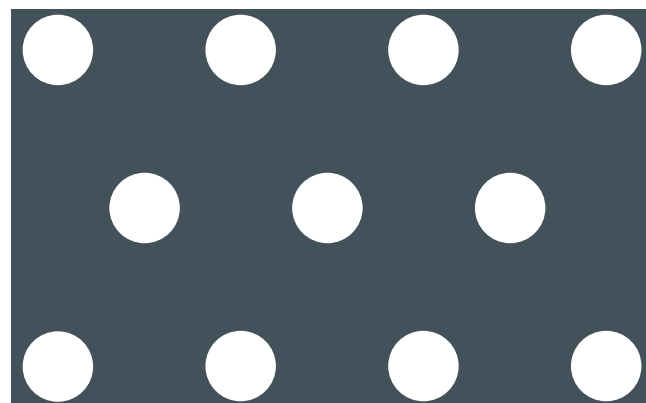

ST0016



No.	R	Z1	Z2	% ΑΕΡΑΣ / OPEN AIR
ST0001	2	6.54	11.34	9.78
ST0002	2	8.70	15.00	5.56
ST0003	3	8.30	15.00	13.11
ST0004	3	10.70	18.75	8.14
ST0005	3.5	10.70	18.75	11.07
ST0006	4	10.98	18.75	14.10
ST0007	4	13.00	22.50	9.92
ST0008	5	12.80	22.50	15.74
ST0009	5	15.40	26.25	11.22
ST0010	5.5	13.50	27.00	15.05
ST0011	6	15.38	26.25	16.17
ST0012	6	17.50	30.00	12.44
ST0013	7	17.50	30.00	16.93
ST0014	8	17.30	30.00	22.37
ST0015	8	21.63	37.50	14.31
ST0016	9	24.17	41.80	14.54
ST0017	10	26.40	45.00	15.27
ST0018	12	30.28	52.50	16.43

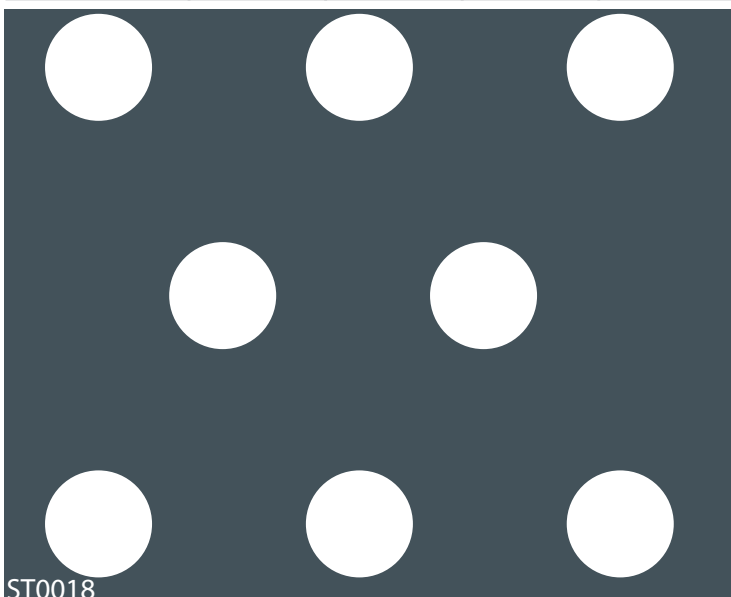

ST0018

# ▶▶ Διάτρητες λαμαρίνες

## ΕΠΙΜΗΚΗ-ΣΤΡΟΓΥΛΕΣ ΟΠΕΣ / LONG GROUNDED HOLES ΠΑΡΑΛΛΗΛΟΓΡΑΜΜΕΣ ΟΠΕΣ / RECTANGULAR HOLES

ΙΣΙΑ ΔΙΑΤΑΞΗ ΟΠΩΝ / STRAIGHT PITCH ΔΙΑΤΑΞΗ ΟΠΩΝ / STRAIGHT PITCH

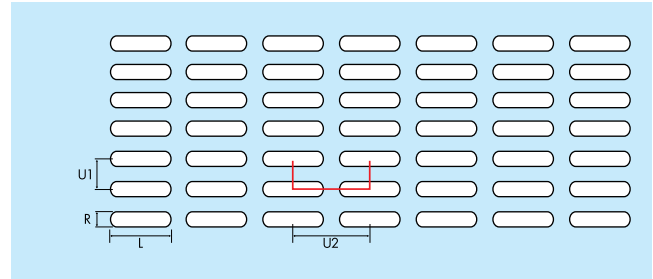
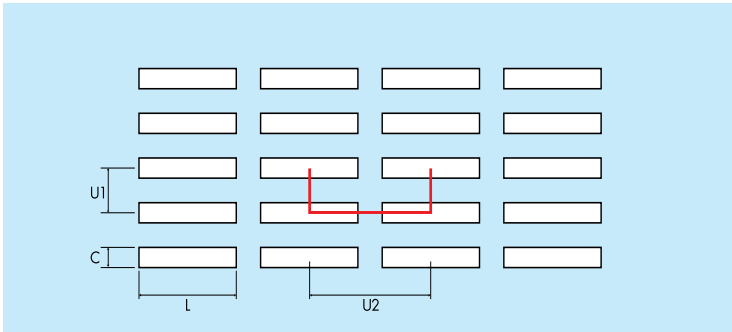

No.	C	L	U1	U2	% ΑΕΡΑΣ OPEN AIR
S0001	5	42.00	35.00	69.00	17.39

No.	R	L	U1	U2	% ΑΕΡΑΣ OPEN AIR
SC0001	3.5	20.00	7.50	26.00	69.09
SC0002	5	20.00	10.00	25.00	75.70
SC0003	7	25.00	13.75	32.50	73.61
SC0004	10	20.00	20.00	30.00	59.50
SC0005	10	20.00	40.00	50.00	17.85
SC0006	10	20.00	20.00	30.00	59.50
SC0007	10	20.00	40.00	50.00	17.85
SC0008	10	100.00	20.00	120.00	81.54



S0001

## ΔΙΑΤΑΞΗ ΟΠΩΝ ΣΕ Ζ / STAGGERED

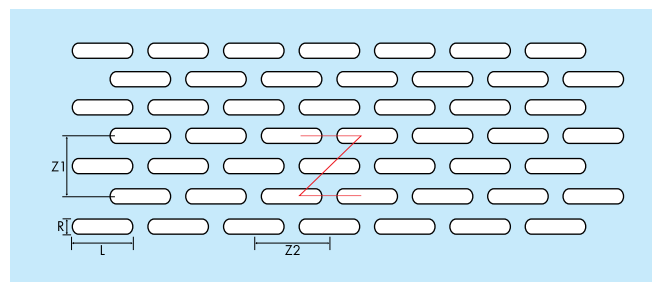

No.	R	L	Z1	Z2	% ΑΕΡΑΣ OPEN AIR
SZ0001	5	20.00	20.00	25.00	37.85
SZ0002	7	25.00	27.50	32.50	36.80
SZ0003	10	20.00	40.00	30.00	29.75

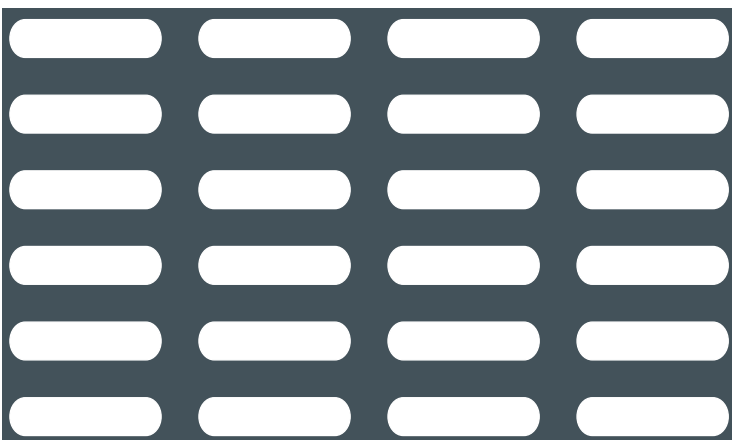

SC0002

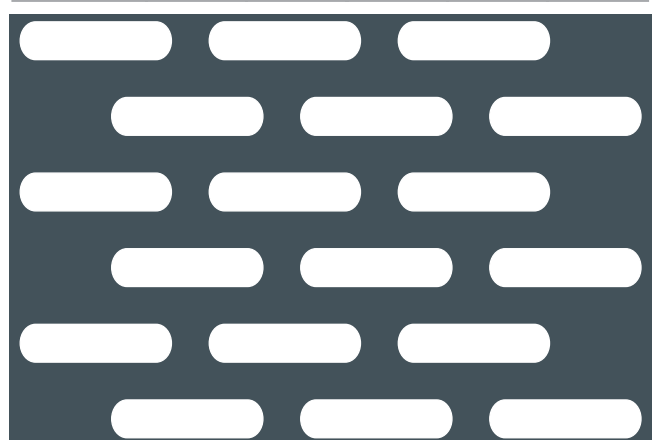

SZ0001





# ▶ Διάτρητες λαμαρίνες ΤΕΤΡΑΓΩΝΕΣ ΟΠΕΣ / SQUARE HOLES

## ΔΙΑΤΑΞΗ ΟΠΩΝ ΣΤΑΓΓΕΡΩ / STAGGERED

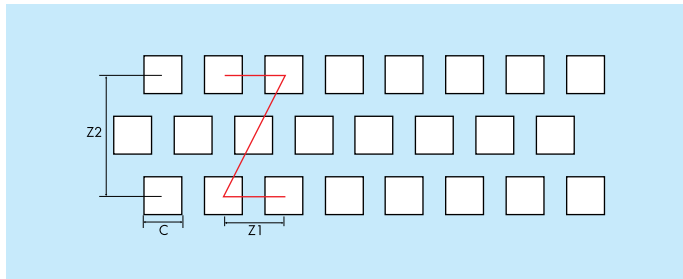

No.	C	Z1	Z2	% ΑΕΡΑΣ / OPEN AIR
STL0001	8	25.00	25.00	20.48
STL0002	10	30.00	30.00	22.22

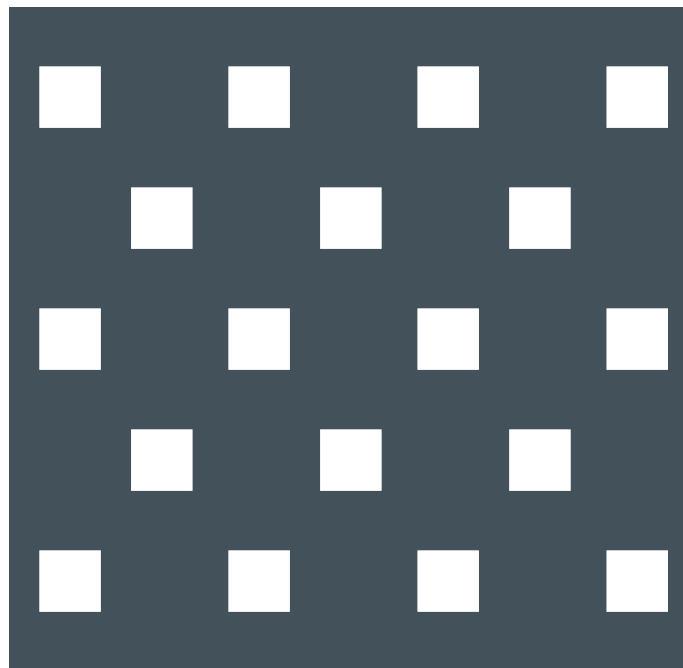

STL0001

## ΤΕΤΡΑΓΩΝΗ ΔΙΑΤΑΞΗ ΟΠΩΝ / SQUARE PITCH

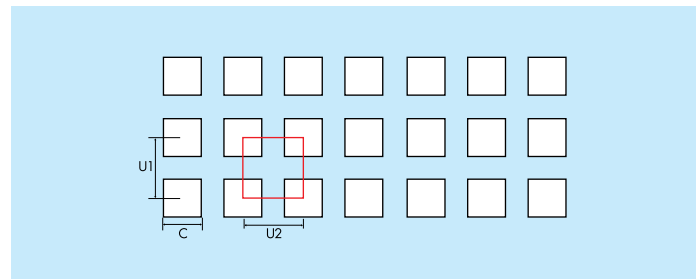

No.	C	U	% ΑΕΡΑΣ / OPEN AIR
SQL0001	6	12.50	23.04
SQL0002	8	12.50	40.96
SQL0003	8	25.00	10.24
SQL0004	10	15.00	44.44
SQL0005	10	30.00	11.11
SQL0006	15	20.50	53.54
SQL0007	15	41.00	13.38
SQL0008	20	39.00	26.30
SQL0009	25	45.00	30.86



SQL0002



SQL0004





## ▶ Διαμορφωμένες λαμαρίνες laser Laser shaped metal sheet

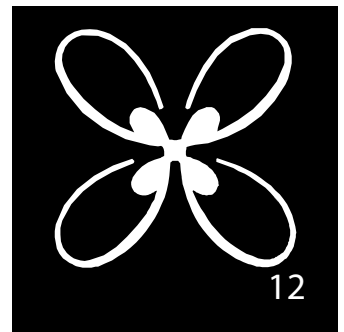
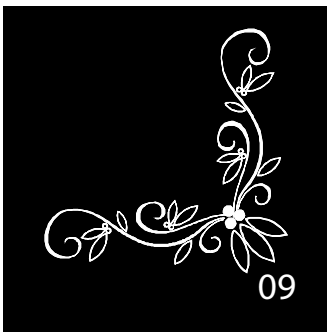
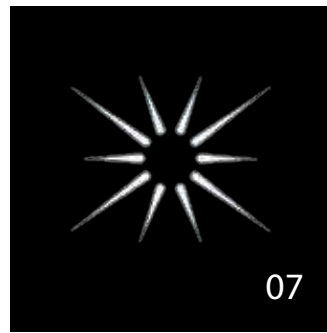

Διαστάσεις λαμαρίνας:

80x90x4, 100x200x4, 120x150x4, 125x200x4, 125x250x4, 150x300x4, 150x300x4, 150x150x4, 100x200x8





▶▶ Κολόνες στήριξης  
Support posts

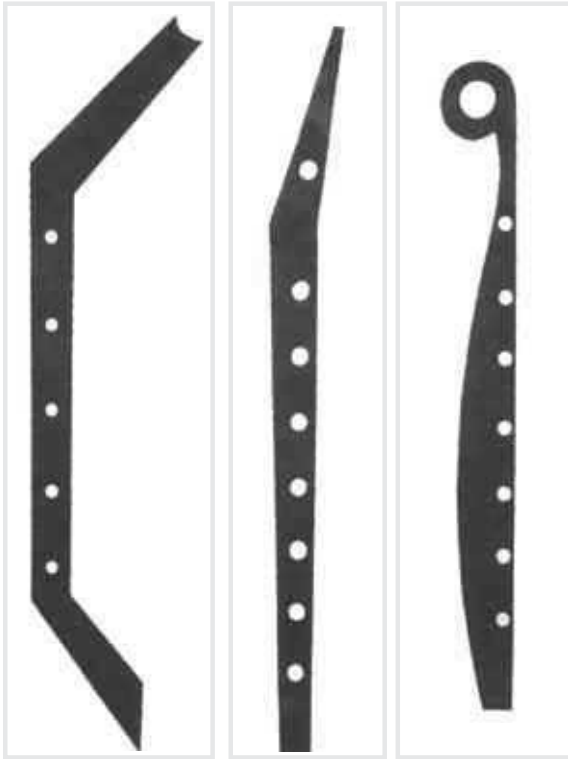

▶SP-1011  
H.985 x L.60  
Ø12

▶SP-1012  
H.1047 x L.80  
Ø22

▶SP-1013  
H.950 x L.90  
Ø16

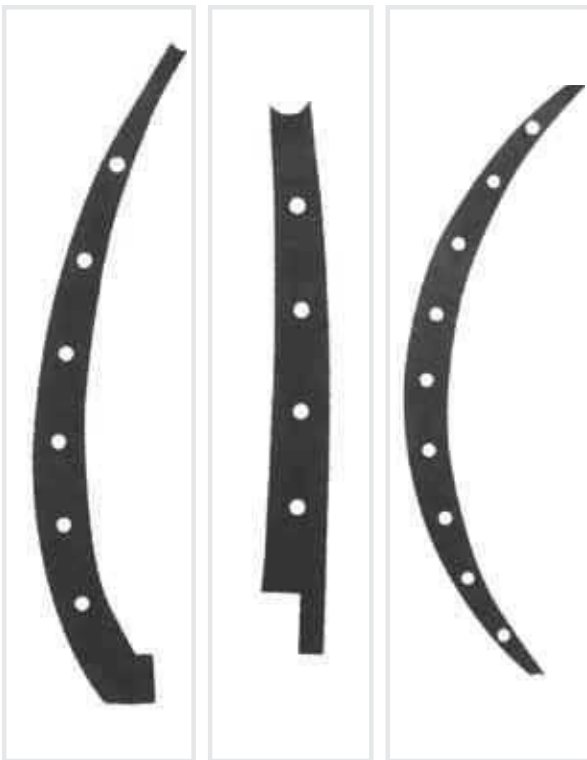

▶SP-1014  
H.945 x L.80  
Ø16

▶SP-1015  
H.800 x L.100  
Ø18

▶SP-1016  
H.900 x L.70  
Ø16





Βιομηχανικός τύπος  
Industrial type





# ► Βιομηχανικές περιφράξεις

Γαλβανισμένες εν θερμώ

Industrial grating fences

Παραδείγματα Εφαρμογής Κιγκλιδωμάτων

Application of grating fences

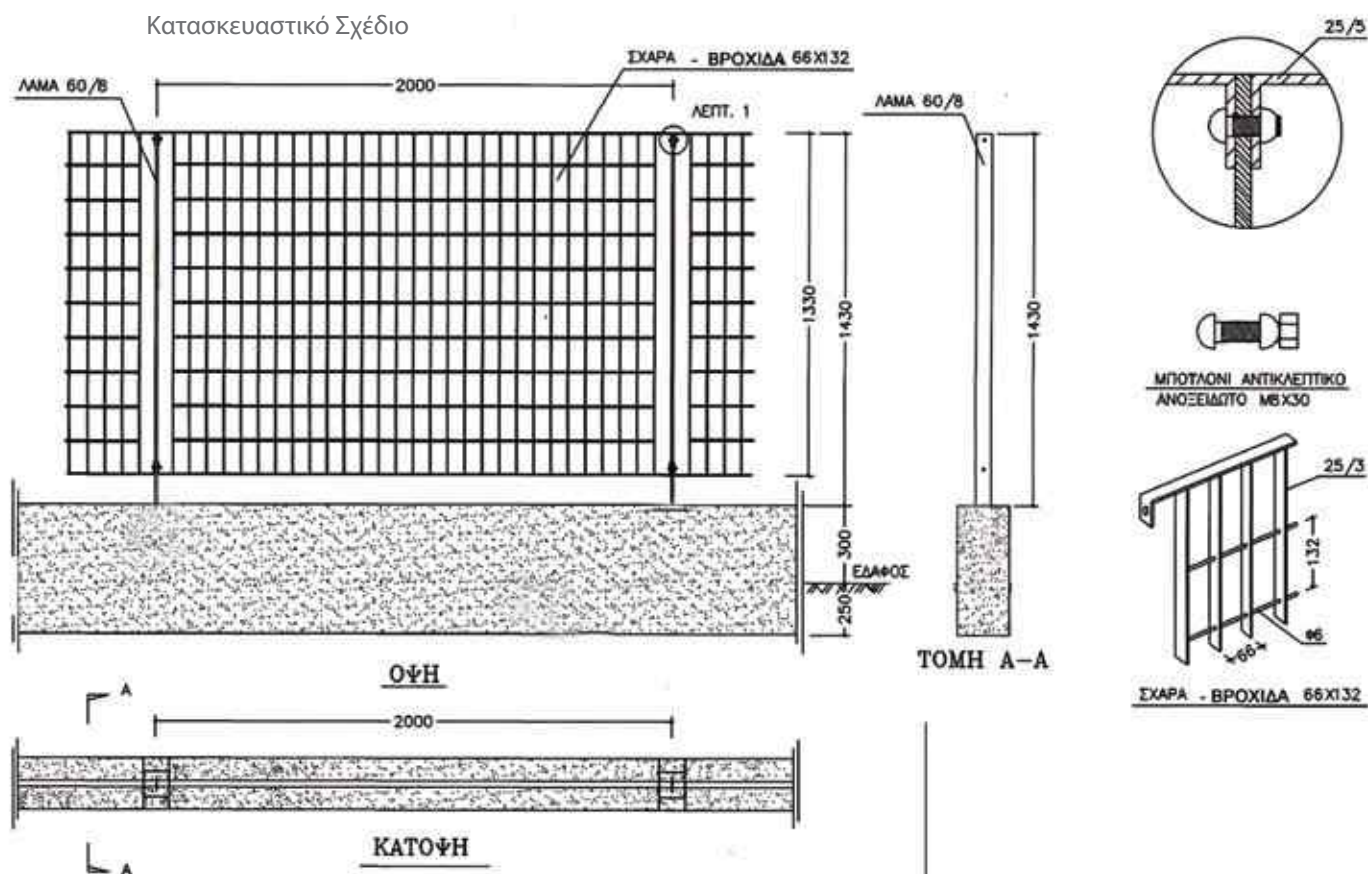

## Συστήματα ασφαλείας - σύνδεσης - στερέωσης



Βάση



Βύσμα



Σημείο σύνδεσης  
λάμα 60/8



Μπουλόني - αντικλεπτικό  
ανοξείδωτο Μ8x30

# ► Βιομηχανικές περιφράξεις

Γαλβανισμένες εν θερμώ

Industrial grating fences

Παραδείγματα Εφαρμογής Κιγκλιδωμάτων

Application of grating fences



ΒΡΟΧΙΔΑ	ΥΨΟΣ ΠΕΡΙΦΡΑΞΗΣ	ΥΨΟΣ ΚΙΓΚΛΙΔΩΜΑΤΟΣ	ΒΑΡΟΣ
66X132	0,9	0,8	19
	1,03	0,93	22,1
	1,16	1,06	25,19
	1,3	1,2	28,52
	1,43	1,33	31,6
	1,56	1,46	34,7
	1,7	1,6	38
	1,8	1,7	40,4
	1,9	1,8	42,78
	2,0	1,9	45,15
2,1	2,0	47,5	

ΒΡΟΧΙΔΑ	ΥΨΟΣ ΠΕΡΙΦΡΑΞΗΣ	ΥΨΟΣ ΚΙΓΚΛΙΔΩΜΑΤΟΣ	ΒΑΡΟΣ
132X132	0,9	0,8	11,9
	1,03	0,93	13,8
	1,16	1,06	15,75
	1,3	1,2	17,83
	1,43	1,33	19,76
	1,56	1,46	21,7
	1,7	1,6	23,78
	1,8	1,7	25,26
	1,9	1,8	26,75
	2,0	1,9	28,24
2,1	2	29,72	

## ► Βιομηχανικές περιφράξεις

Γαλβανισμένες εν θερμώ

Industrial grating fences

Παραδείγματα Εφαρμογής Κιγκλιδωμάτων

Application of grating fences



Οριζόντιες εφαρμογές



Περιφραξη βιομηχανικού χώρου



Περιφραξη αθλητικών εγκαταστάσεων



Περιφραξη σχολείου



Περιφραξη κήπου

# ►► Βιομηχανικές πόρτες

Γαλβανισμένες εν θερμώ

## Industrial gliding doors



ΜΟΝΟΦΥΛΛΕΣ ΠΟΡΤΕΣ

ΥΨΟΣ	ΠΛΑΤΟΣ
1.50m	1.00m
1.70m	1.00m
1.60m	1.00m
2.00m	1.00m



ΔΙΦΥΛΛΕΣ ΠΟΡΤΕΣ

ΥΨΟΣ	ΠΛΑΤΟΣ
1.70m	1.80m
1.70m	2.50m
2.00m	1.80m
2.00m	2.50m



ΣΥΡΟΜΕΝΕΣ ΠΟΡΤΕΣ

ΥΨΟΣ	ΠΛΑΤΟΣ
1.70m	4.25m
1.70m	6.00m
2.00m	4.25m
2.00m	6.00m

# ► Βιομηχανικές σχάρες

Γαλβανισμένες εν θερμώ

Industrial grating

Ενδεικτικός πίνακας αντοχής σχαρών

ΒΡΟΧΙΔΑ ΣΧΑΡΑΣ	ΛΑΜΑ ΣΧΑΡΑΣ ύψος / πλάτος mm	ΠΛΑΤΟΣmm x ΜΗΚΟΣ ΣΧΑΡΑΣ 1000m																
		137	150	200	248	300	335	400	500	600	700	800	900	1000	1200	1500	2000	
34x38	25x2																	
	25x3																	
	30x2																	
	30x3																	
	40x3																	
	40x5																	
	50x5																	
	<b>ΛΑΜΑ ΣΧΑΡΑΣ</b>		<b>ΠΛΑΤΟΣmm x ΜΗΚΟΣ ΣΧΑΡΑΣ 1000m</b>															
	ύψος / πλάτος mm		137	150	200	248	300	335	400	500	600	700	800	900	1000	1200	1500	2000
	25x2																	
	25x3																	
	30x2																	
	30x3																	
	40x3																	
	40x5																	
	50x5																	
	<b>ΛΑΜΑ ΣΧΑΡΑΣ</b>		<b>ΠΛΑΤΟΣmm x ΜΗΚΟΣ ΣΧΑΡΑΣ 1000m</b>															
	ύψος / πλάτος mm		137	150	200	248	300	335	400	500	600	700	800	900	1000	1200	1500	2000
25x2																		
25x3																		
30x2																		
30x3																		
40x3																		
40x5																		
50x5																		
<b>ΛΑΜΑ ΣΧΑΡΑΣ</b>		<b>ΠΛΑΤΟΣmm x ΜΗΚΟΣ ΣΧΑΡΑΣ 1000m</b>																
ύψος / πλάτος mm		137	150	200	248	300	335	400	500	600	700	800	900	1000	1200	1500	2000	
25x2																		
25x3																		
30x2																		
30x3																		
40x3																		
40x5																		
50x5																		
<b>ΛΑΜΑ ΣΧΑΡΑΣ</b>		<b>ΠΛΑΤΟΣmm x ΜΗΚΟΣ ΣΧΑΡΑΣ 1000m</b>																
ύψος / πλάτος mm		137	150	200	248	300	335	400	500	600	700	800	900	1000	1200	1500	2000	
25x2																		
25x3																		
30x2																		
30x3																		
40x3																		
40x5																		
50x5																		

- ΚΛΑΣΗ 1**  
ΠΕΖΟΙ
- ΚΛΑΣΗ 2**  
ΙΧ  
500kg / ρόδα
- ΚΛΑΣΗ 3**  
ΜΙΚΡΑ ΦΟΡΤΗΓΑ  
1000kg / ρόδα
- ΚΛΑΣΗ 4**  
ΦΟΡΤΗΓΑ  
2000kg / ρόδα
- ΚΛΑΣΗ 5**  
ΤΡΙΑΞΟΝΙΚΑ ΦΟΡΤΗΓΑ  
10000kg / ρόδα

ΒΡΟΧΙΔΑ	No ΣΧΑΡΑΣ	ΛΑΜΑ	ΒΑΡΟΣ
34x38	137x1000 mm	25x3	4,62
	150x1000 mm	25x2	3,49
	200x1000 mm	25x2	4,53
	200x1000 mm	25x3	5,51
	200x1000 mm	30x3	7,00
	248x1000 mm	25x3	6,25
	248x1000 mm	30x2	6,11
	248x1000 mm	30x3	7,47
	248x1000 mm	40x3	10,8
	300x1000 mm	25x3	7,79
	300x1000 mm	30x3	9,99
	300x1000 mm	40x3	11,88
	335x1000 mm	25x3	9,01
	335x1000 mm	30x3	11,20
	335x1000 mm	40x3	13,75
	400x1000 mm	25x3	9,30
	400x1000 mm	30x2	9,22
	400x1000 mm	30x3	12,90
	400x1000 mm	40x3	16,66
	400x1000 mm	40x5	25,73
400x1000 mm	50x5	31,85	
	500x1000 mm	25x3	11,17
	500x1000 mm	30x2	11,34
	500x1000 mm	30x3	15,88
	500x1000 mm	40x3	18,42
	500x1000 mm	40x5	31,52
	500x1000 mm	50x5	38,85
	600x1000 mm	25x3	14,05
	600x1000 mm	30x2	13,25
	600x1000 mm	30x3	18,62
	600x1000 mm	40x3	23,15
	600x1000 mm	40x5	35,04
	700x1000 mm	30x2	15,37
	800x1000 mm	25x3	17,95
	800x1000 mm	30x2	17,28
	800x1000 mm	30x3	24,30
	800x1000 mm	40x3	30,94
	800x1000 mm	40x5	48,45
	900x1000 mm	30x2	19,40
	1000x1000 mm	25x3	22,31
	1000x1000 mm	30x2	21,53
	1000x1000 mm	30x3	29,59
	1000x1000 mm	40x5	61,35

# ► Σχάρες - Καναλιών ομβρίων

Γαλβανισμένες εν θερμώ

## Drains - Pits

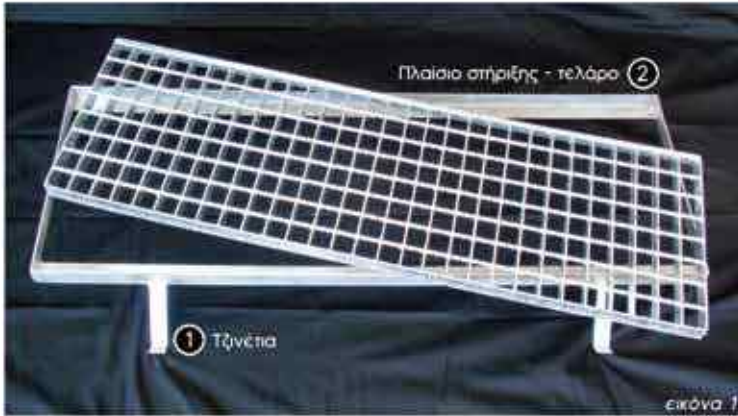

Σύστημα ασφάλειας σχαρών



Εξαρτήματα σύνδεσης



## ► Βιομηχανικές σχάρες

Γαλβανισμένες εν θερμώ

Παραδείγματα εφαρμογής

Application of grating



περσίδες



προστατευτικά δέντρων



σκάρες βαρέου τύπου



καναλιών ομβρίων



καπάκια φρεστίων



σκάρες δαπέδων - διαδρόμων

## ►► Βιομηχανικές σκάρες

Γαλβανισμένες εν θερμώ

Ηλεκτροπρεσαριστά - Αντιολισθητικά Σκαλοπάτια

Forgewelded - Non slippery stairs

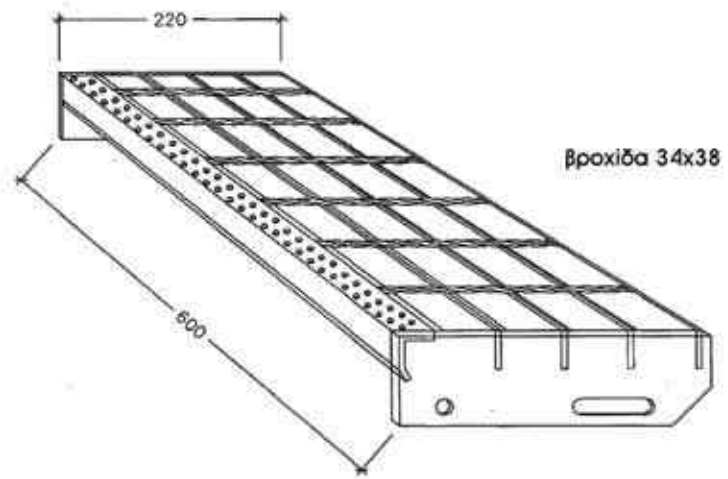

ΣΚΑΛΟΠΑΤΙ	ΛΑΜΑ	ΒΑΡΟΣ
600x200mm	25x3	4.03
600x220mm	25x3	4.42
760x220mm	25x3	5.25
870x220mm	25x3	5.85
1000x240mm	30X3	8.01

Τα σκαλοπάτια κατασκευάζονται από ηλεκτροπρεσαριστή οχάρα, με εγκάρσια ελικοειδή ράβδο τετραγωνικής διατομής. Προσφέρονται γαλβανισμένα εν θερμώ.





▶▶ Πρεσαριστά σκαλοπάτια  
Welded stairs

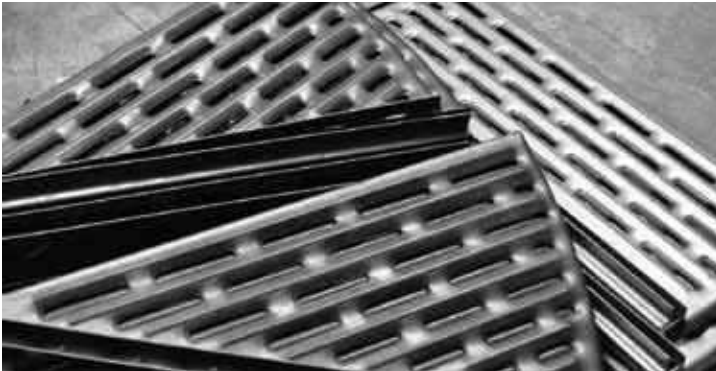

**ΣΚΑΛΟΠΑΤΙΑ ΠΡΕΣΑΡΙΣΤΑ**  
Κατασκευάζονται από λαμαρίνα πρεσαριστή.

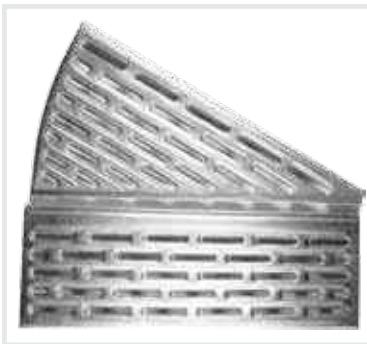

**ΑΡΙΣΤΕΡΑ**  
H.340 x L.600mm



**ΔΕΞΙΑ**  
H.340 x L.600mm

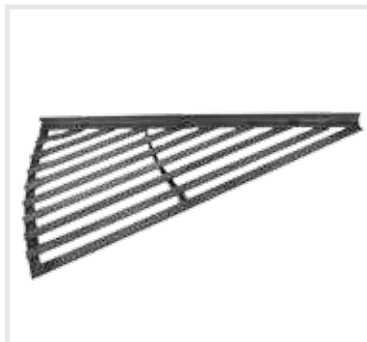

**ΑΡΙΣΤΕΡΑ**  
H.340 x L.600mm

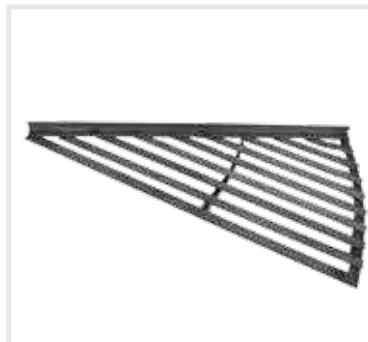

**ΔΕΞΙΑ**  
H.340 x L.600mm



**ΣΚΑΛΟΠΑΤΙΑ ΑΠΟ ΛΑΜΑΚΙ**  
Κατασκευάζονται από λαμάκι 16x4.  
H.220 x L.600mm



**ANCO**

*Εργοστάσιο Επεξεργασίας Σιδήρου*

**ANCO ΚΩΝΣΤΑΝΤΙΝΟΥ Α.Β.Ε.Ε.**

Κεντρικό κατάστημα:

**Λ. Κορωπίου - Μαρκοπούλου 51, Κορωπί Αττικής**

**Τηλ.: 210 6620934 - 210 6620936 - 210 9934604**

**Φαξ: 210 6620938**

Υποκατάστημα:

**Σουλίου 7, Άγιος Δημήτριος, Αττική, Τηλ.: 210 9921339**

Εργοστάσιο:

**Φαλαισίας 6, Κορωπί Αττικής**

**www.anco.com.gr - email: info@anco.com.gr**